

# Queensland Clinical Guidelines

*Translating evidence into best clinical practice*

## Maternity and Neonatal **Clinical Guideline**

### Maternity care for mothers and babies during the COVID-19 pandemic

Document title:	Maternity care for mothers and babies during COVID-19 pandemic ( <i>formerly titled Perinatal care of suspected or confirmed COVID-19 pregnant women</i> )
Publication date:	26 March 2020
Document number:	MN20.63-V3-R25
Document supplement:	The document supplement is integral to and should be read in conjunction with this guideline.
Amendments:	Full version history is supplied in the document supplement.
Amendment date:	29 April 2020
Replaces document:	MN20.63-V2-R25
Author:	Queensland Clinical Guidelines
Audience:	Health professionals in Queensland public and private maternity and neonatal services
Review date:	March 2025
Endorsed by:	Queensland Clinical Guidelines Steering Committee Statewide Maternity and Neonatal Clinical Network (Queensland)
Contact:	Email: <a href="mailto:Guidelines@health.qld.gov.au">Guidelines@health.qld.gov.au</a> URL: <a href="http://www.health.qld.gov.au/qcg">www.health.qld.gov.au/qcg</a>



### Cultural acknowledgement

We acknowledge the Traditional Custodians of the land on which we work and pay our respect to the Aboriginal and Torres Strait Islander elders past, present and emerging.

### Disclaimer

This guideline is intended as a guide and provided for information purposes only. The information has been prepared using a multidisciplinary approach with reference to the best information and evidence available at the time of preparation. No assurance is given that the information is entirely complete, current, or accurate in every respect.

The guideline is not a substitute for clinical judgement, knowledge and expertise, or medical advice. Variation from the guideline, taking into account individual circumstances, may be appropriate.

This guideline does not address all elements of standard practice and accepts that individual clinicians are responsible for:

- Providing care within the context of locally available resources, expertise, and scope of practice
- Supporting consumer rights and informed decision making, including the right to decline intervention or ongoing management
- Advising consumers of their choices in an environment that is culturally appropriate and which enables comfortable and confidential discussion. This includes the use of interpreter services where necessary
- Ensuring informed consent is obtained prior to delivering care
- Meeting all legislative requirements and professional standards
- Applying standard precautions, and additional precautions as necessary, when delivering care
- Documenting all care in accordance with mandatory and local requirements

Queensland Health disclaims, to the maximum extent permitted by law, all responsibility and all liability (including without limitation, liability in negligence) for all expenses, losses, damages and costs incurred for any reason associated with the use of this guideline, including the materials within or referred to throughout this document being in any way inaccurate, out of context, incomplete or unavailable.

**Recommended citation:** Queensland Clinical Guidelines Perinatal care of suspected or confirmed COVID-19 pregnant women. Guideline No. MN20.63-V3-R25. Queensland Health. 2020. Available from: <http://www.health.qld.gov.au/qcg>

© State of Queensland (Queensland Health) 2020



This work is licensed under a Creative Commons Attribution-NonCommercial-NoDerivatives V4.0 International licence. In essence, you are free to copy and communicate the work in its current form for non-commercial purposes, as long as you attribute Queensland Clinical Guidelines, Queensland Health and abide by the licence terms. You may not alter or adapt the work in any way. To view a copy of this licence, visit <https://creativecommons.org/licenses/by-nc-nd/4.0/deed.en>  
For further information, contact Queensland Clinical Guidelines, RBWH Post Office, Herston Qld 4029, email [Guidelines@health.qld.gov.au](mailto:Guidelines@health.qld.gov.au). For permissions beyond the scope of this licence, contact: Intellectual Property Officer, Queensland Health, GPO Box 48, Brisbane Qld 4001, email [ip\\_officer@health.qld.gov.au](mailto:ip_officer@health.qld.gov.au), phone (07) 3234 1479.

**Flowchart: Triage and risk assessment of suspected or confirmed COVID-19 woman**

**For women self identifying with symptoms:**  
 Screen before arrival where possible (e.g. by phone)  
 Triage in location separate from usual admission routes  
 Recommend/provide surgical face mask at face-to face assessment

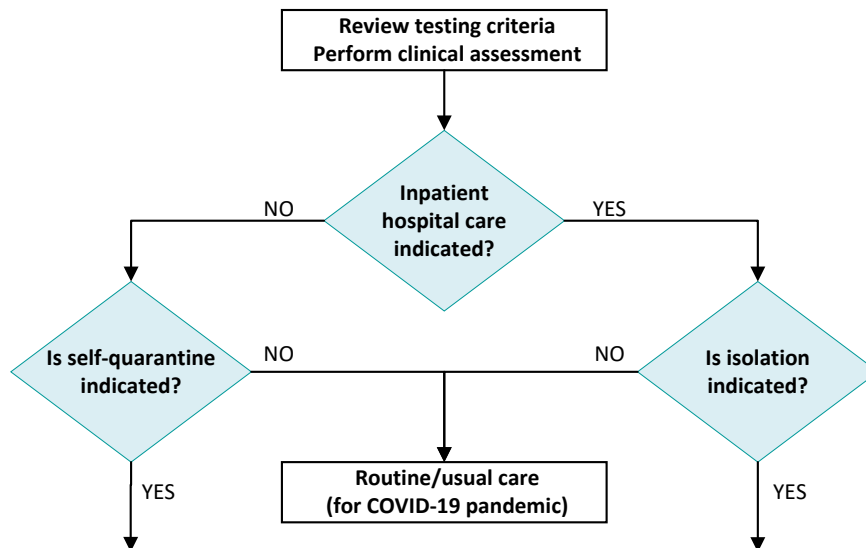

**Self-quarantine/self-isolation**

- Advise to return home using personal transport (not public transport or ride sharing options)

**Ongoing antenatal care**

- Resume usual antenatal care after 14 days symptom free or negative test result
- Arrange alternate mode of antenatal care while self-quarantined (if care cannot be delayed)
- Advise to telephone maternity service if concerned

**COVID-19**

- Advise about standard hygiene precautions
- Provide information about COVID-19 (e.g. fact sheet)

**Do not**

- Go out to school/work/public areas or use public transport

**Do**

- Stay indoors at home
- Avoid contact with visitors
- Ventilate rooms by opening windows
- Separate self from other household members

**Return to defined restricted area**

- Two weeks quarantine required to gain Human Biosecurity Approval and Local Council permit

**Testing criteria**

- As per current QH recommendations (updated frequently)
- Available at <https://www.health.qld.gov.au/clinical-practice/guidelines-procedures/novel-coronavirus-qld-clinicians>

**CLOSE CONTACT (with confirmed or suspected case)**

- More than 15 minutes face-to-face contact
- More than 2 hours in a closed space (including households)

**Notify maternity services ASAP**

**On admission/universal care**

- Isolate
- Follow standard infection prevention and control and requirements for PPE
- Alert midwifery/obstetric/neonatal/infectious diseases teams
- Limit visitors
- Symptomatic treatment as indicated

**Retrieval/transfer**

- COVID-19 positive alone not an indication

**Antenatal**

- Perform necessary medical imaging
- Fetal surveillance as clinically indicated
- Maternal surveillance and SpO<sub>2</sub>

**Birth**

- Negative pressure room (if possible)
- Mode of birth not influenced by COVID-19 unless urgent delivery indicated
- Early consideration of neuraxial blockade (to minimise risk from emergency GA)
- Lower threshold for escalation of clinical concerns

**Co-location of mother and baby**

- Co-location generally recommended
- Discuss risk/benefit with parents
- Determine need on individual basis

**Feeding (breastfeeding or formula)**

- Support maternal choice
- Breastfeeding not contraindicated

**Risk minimisation strategies**

- Inform about hand hygiene, sneeze and coughing etiquette, face mask use, close contact, social distancing and precautions during baby care, sterilisation

GA: general anaesthetic, QH: Queensland Health, SpO<sub>2</sub> peripheral capillary oxygen saturation

**Flowchart: Neonate of suspected or confirmed COVID-19 mother**

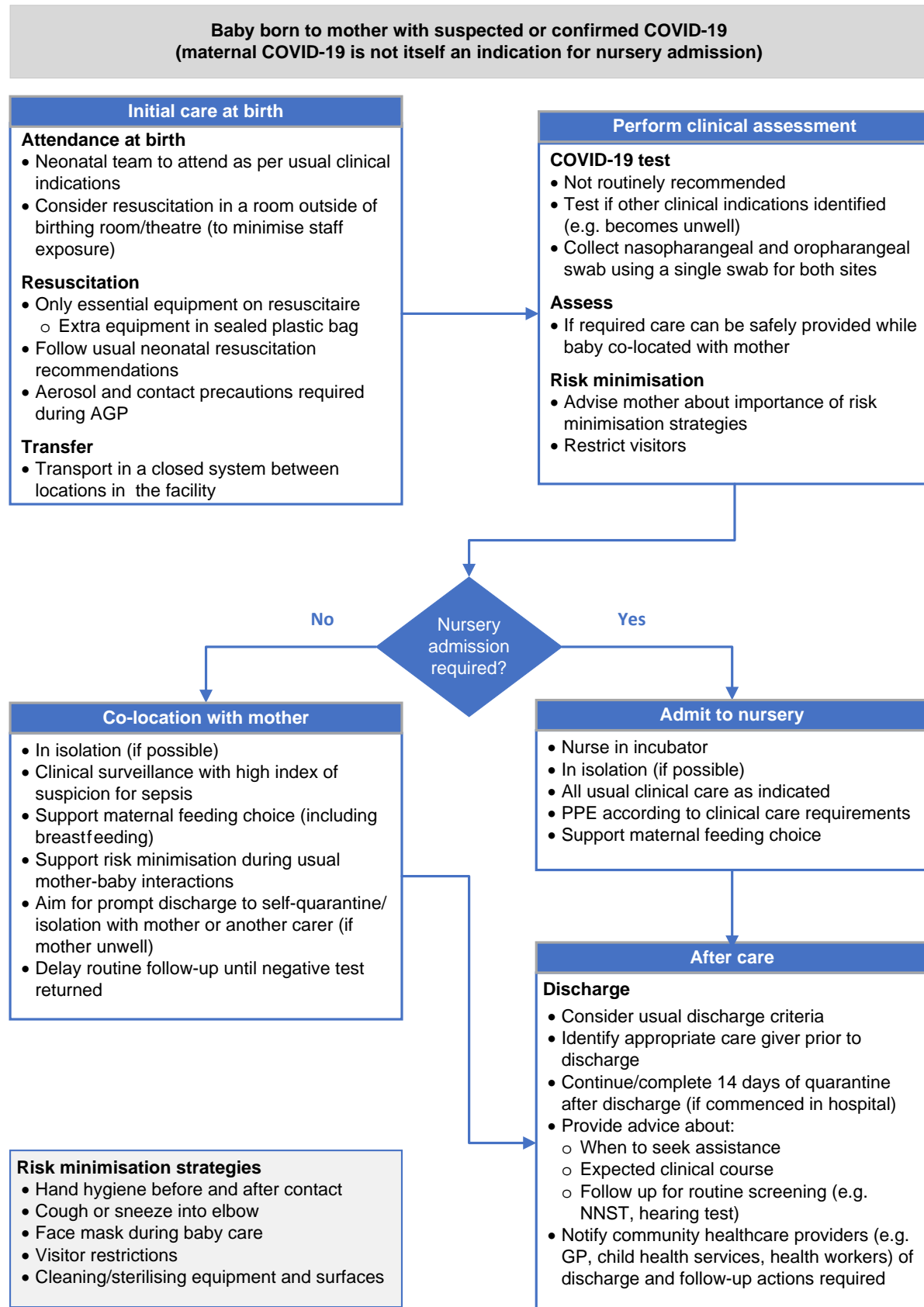

AGP: aerosol generating procedure, GP: general practitioner, NNST: neonatal screening test, PPE: personal protective equipment

**Flowchart: Assessment of inpatient woman**

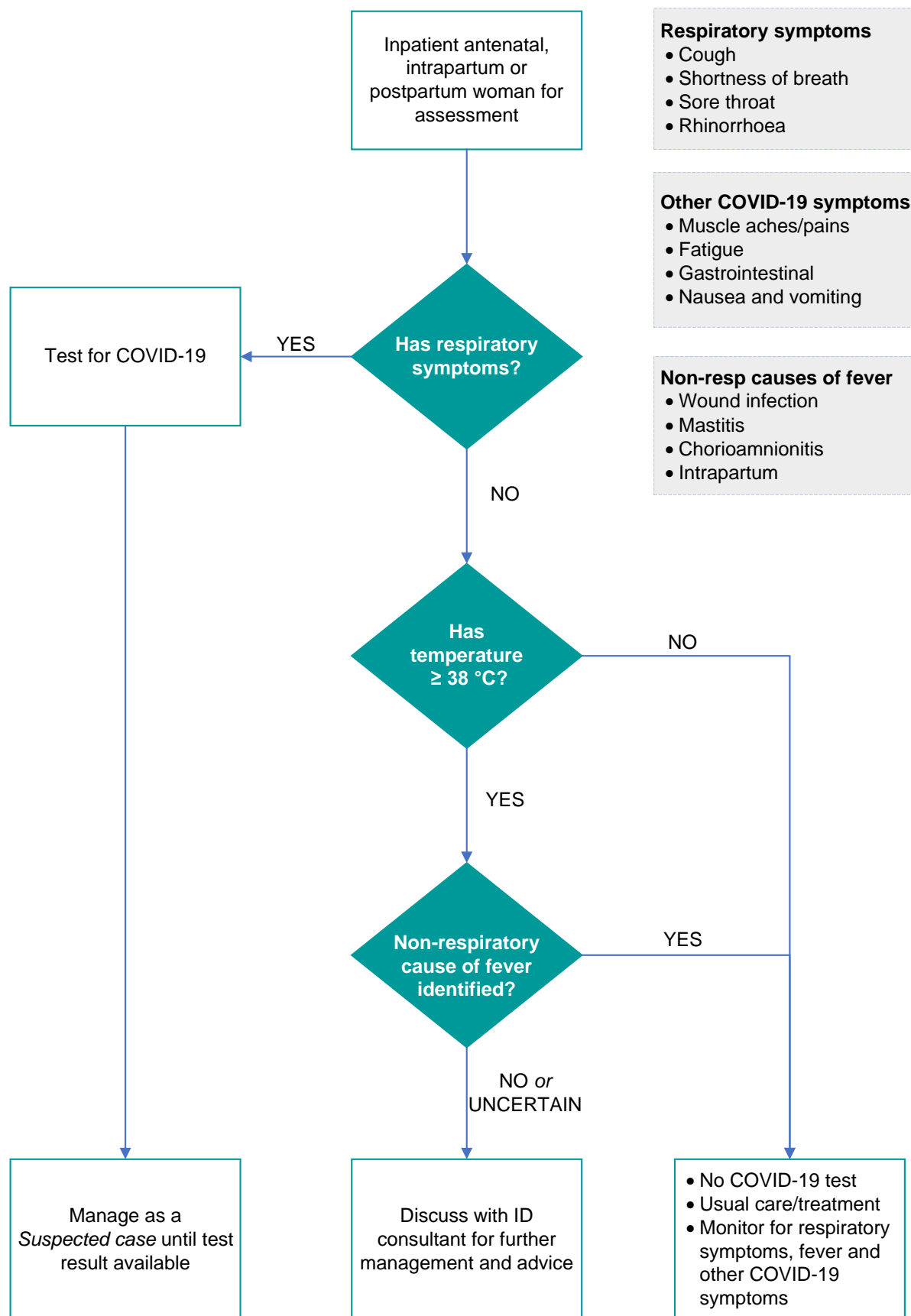

ID: infectious diseases, ≥: greater than or equal to, non-resp: non-respiratory

Flowchart: F20.63-5-V1-R25

**Table of Contents**

Abbreviations .....	7
Definitions .....	7
1 Introduction .....	8
1.1 Background .....	8
1.2 Data collection .....	8
2 Maternity care during COVID-19 pandemic .....	9
2.1 Perinatal mental health (for all women) .....	9
2.2 Visiting in-patient mothers and babies .....	9
2.3 Home visiting during COVID-19 pandemic (for all women) .....	10
2.4 Specific recommendations for maternity care (for all women) .....	11
3 Risk management .....	12
3.1 Risk containment (for all women) .....	12
3.2 Risk assessment .....	12
3.3 Testing .....	13
3.4 Personal protective equipment .....	14
3.5 PPE recommendations by care type .....	14
3.6 Self-quarantine/isolation .....	15
4 In-hospital maternity care (if suspected or confirmed COVID-19) .....	16
4.1 In-hospital antenatal care (if confirmed or suspected COVID-19) .....	17
4.2 Labour and birth (if suspected or confirmed COVID-19) .....	18
4.3 Postnatal care (if suspected or confirmed COVID-19) .....	19
5 Newborn care .....	20
5.1 General principles (for all babies) .....	20
5.2 Risk management (baby of suspected or confirmed COVID-19 mother) .....	21
5.3 Initial care (baby of suspected or confirmed COVID-19 mother) .....	22
5.4 Respiratory support management (if COVID-19 suspected or confirmed) .....	23
5.5 Newborn COVID-19 testing .....	23
5.6 Discharge (following suspected or confirmed COVID-19) .....	24
References .....	25
Appendix A: Modified schedules for low-risk women during COVID-19 .....	28
Appendix B: Recommended nitrous oxide circuits .....	30
Appendix C: General principles during initial stabilisation .....	31
Acknowledgements .....	33

**List of Tables**

Table 1. COVID-19 .....	8
Table 2. Perinatal data collection .....	8
Table 3. Perinatal mental health .....	9
Table 4. Hospital visiting .....	9
Table 5. Home visiting during COVID-19 pandemic .....	10
Table 6. Specific considerations for maternity care .....	11
Table 7. Containment and risk minimisation .....	12
Table 8. Risk assessment .....	12
Table 9. Testing .....	13
Table 10. Personal protective equipment .....	14
Table 11. PPE by type of care .....	14
Table 12. Self-quarantine/isolation .....	15
Table 13. In hospital maternity care .....	16
Table 14. Antenatal care while inpatient .....	17
Table 15. Labour and birth .....	18
Table 16. Postnatal care .....	19
Table 17. General principles .....	20
Table 18. Risk management .....	21
Table 19. Baby of suspected/positive COVID-19 mother .....	22
Table 20. respiratory support management .....	23
Table 21. Newborn testing .....	23
Table 22. Discharge .....	24

**Abbreviations**

AGP	Aerosol generating procedure
CPAP	Continuous positive airway pressure
DNA	Deoxyribonucleic acid
GDM	Gestational diabetes mellitus
ICU	Intensive care unit
LISA	Less invasive surfactant administration
MERS	Middle eastern respiratory syndrome
MSG	Message
NNST	Neonatal screening test (also known as newborn bloodspot screening)
OGTT	Oral glucose tolerance test
PPE	Personal protective equipment
RESPCR	Full respiratory virus polymerase chain reaction (PCR)
SARS	Severe acute respiratory syndrome
SOMANZ	Society of Obstetric Medicine of Australia and New Zealand
SpO <sub>2</sub>	Peripheral capillary oxygen saturations
VTE	Venous thromboembolism
VTM	Viral transport medium

**Definitions**

Aerolisation	The production of small particles of water which, rather than falling to the ground (as droplets do), can flow through the air and spread more widely. <sup>1</sup>
Close contact	In the context of time spent with a confirmed or suspected COVID-19 case, defined as: <ul style="list-style-type: none"> <li>• In the 24 hours before onset of symptoms in a confirmed/suspected case<sup>2</sup>: <ul style="list-style-type: none"> <li>○ More than 15 minutes face-to-face contact</li> <li>○ More than 2 hours in a closed space (including households)</li> </ul> </li> </ul>
Cohorting	Placement of patients with similar/same condition in the same physical location. <sup>3</sup>
Coronavirus	Broad name for a type of virus.
COVID-19	The disease caused by SARS-CoV-2.
SARS-CoV-2	Name of virus causing COVID-19 disease.
Self-isolation	Used to separate ill people from those who are healthy until they are declared recovered.
Self-quarantine	Used to restrict the movement of a well person who may have been exposed for the period when they could become unwell (duration 14 days for COVID-19).
Physical (social) distancing	Staying 1.5 metres from other people and avoiding close contact. Also referred to as physical distancing or social distancing
Standard precautions <sup>4</sup>	Follow standard precautions for infection prevention and control at all times. This is additional to other transmission precautions required during COVID-19 (e.g. contact, droplet, airborne precautions).  Standard precautions consist of hand hygiene, appropriate use of personal protective equipment, safe use and disposal of sharps, routine environmental cleaning, reprocessing of re-usable medical equipment and instruments, respiratory hygiene and cough etiquette, aseptic technique, waste management, appropriate handling of linen.

## 1 Introduction

There is limited data and evidence about the effects of COVID-19 during pregnancy. Information is current at the time of publication, but new information is emerging daily, and this may affect recommendations. This guideline applies to women who do not require critical care.

### 1.1 Background

Table 1. COVID-19

Aspect	Consideration
<b>Coronavirus</b>	<ul style="list-style-type: none"> <li>• COVID-19 is the disease caused by SARS-CoV-2</li> <li>• SARS-CoV-2 is the name of the virus (a type of coronavirus) first identified in late 2019</li> <li>• Coronavirus is the broad name for a type of virus. There are different kinds of coronaviruses (e.g. Severe Acute Respiratory Syndrome (SARS), Middle Eastern Respiratory Syndrome (MERS))</li> </ul>
<b>Onset</b>	<ul style="list-style-type: none"> <li>• Median time from onset to clinical recovery (non-pregnant cases)<sup>5</sup> <ul style="list-style-type: none"> <li>○ Mild cases approximately 2 weeks</li> <li>○ Severe or critical cases 3–6 weeks</li> </ul> </li> </ul>
<b>Transmission of COVID-19</b>	<ul style="list-style-type: none"> <li>• Most likely spread from person-to-person through close contact with an infected person's cough or sneeze or by touching objects or contaminated surfaces and then touching the mouth, eyes or face<sup>6</sup></li> <li>• Vertical transmission has not been convincingly demonstrated from current data<sup>7</sup> <ul style="list-style-type: none"> <li>○ Three babies<sup>8,9</sup> reported to have SARS-CoV-2 IgM in serum. As IgM does not cross the placenta, and usually does not appear until 3–7 days after infection, in-utero infection may have occurred</li> </ul> </li> <li>• No detectable viral DNA found in amniotic fluid, serum, placenta, breast milk<sup>10</sup> or vaginal fluid<sup>11</sup> (although few women have been tested)</li> <li>• SARS-CoV-2 has been detected in stools<sup>12-14</sup></li> </ul>
<b>Physiology of pregnancy and COVID-19</b>	<ul style="list-style-type: none"> <li>• Immunosuppression of pregnancy may impact severity of symptoms<sup>15</sup></li> <li>• Due to physiological changes, when compared with their non-pregnant counterparts, pregnant women with lower respiratory tract infections may experience worse outcomes (e.g. preterm birth, fetal growth restriction and perinatal mortality)<sup>16,17</sup></li> <li>• Increased oxygen demands of pregnancy may increase risk of respiratory compromise in infected pregnant women</li> </ul>

### 1.2 Data collection

To help inform future care and understanding of the COVID-19 disease, data is needed. Specify COVID-19 related codes in the Perinatal Data Collection. Refer to Statistical Services Branch website for details of agreed codes at <https://www.health.qld.gov.au/hvu/collections/dchome>.

Table 2. Perinatal data collection

Aspect	Consideration
<b>Perinatal online (PNO)</b>	<ul style="list-style-type: none"> <li>• Codes to facilitate data collection have been added to the <i>Medical Conditions</i> and <i>Neonatal Morbidity</i> selections in the data collection form</li> <li>• Select the most appropriate set of codes</li> </ul>
<b>Other electronic data collection systems</b>	<ul style="list-style-type: none"> <li>• Facilitate modification to code sequence as per the Queensland Perinatal Data Collection COVID-19 requirements as soon as possible</li> <li>• If system modification is delayed, manually add details to file extract where possible</li> </ul>
<b>Paper collection (MR63d)</b>	<ul style="list-style-type: none"> <li>• Record maternal details at <i>Medical conditions viral infections</i></li> <li>• Record neonatal details at <i>Neonatal morbidities</i></li> </ul>



## 2 Maternity care during COVID-19 pandemic

This section applies to all pregnant women irrespective of COVID-19 status.

### 2.1 Perinatal mental health (for all women)

Table 3. Perinatal mental health

Aspect	Consideration
<b>Context</b>	<ul style="list-style-type: none"> <li>Pregnant women and their families are likely to experience heightened anxiety and stress related to the COVID-19 pandemic in the community<sup>18,19</sup></li> <li>Current limitations in the evidence about the effects of the disease in pregnancy and on the newborn are also likely to be significant stressors<sup>18</sup> <ul style="list-style-type: none"> <li>This can be assumed irrespective of personal COVID-19 status (negative, suspected, or confirmed)</li> </ul> </li> <li>The long-term mental health implications for women may lead to a significant increase in the need for services in the future</li> </ul>
<b>Strategies</b>	<ul style="list-style-type: none"> <li>Provide consistent information to women and their families<sup>18</sup> (e.g. refer to Queensland Health sources <a href="https://www.qld.gov.au/health/conditions/health-alerts/coronavirus-covid-19">https://www.qld.gov.au/health/conditions/health-alerts/coronavirus-covid-19</a>)</li> <li>Adhere to usual/standard care recommendations (e.g. woman centred care, respectful communication, consent and informed decision making) <ul style="list-style-type: none"> <li>Refer to Queensland Clinical Guideline: <i>Standard care</i><sup>20</sup></li> </ul> </li> </ul>
<b>Model of care</b>	<ul style="list-style-type: none"> <li>Support models of care that maximise continuity (e.g. midwifery continuity of care, case management, midwife navigator, general practitioner (GP), private practice midwives or cultural supports such as health worker or a community organisation)</li> </ul>
<b>Domestic/family violence</b>	<ul style="list-style-type: none"> <li>Maintain awareness that domestic and family violence may increase in association with social isolation</li> <li>Screen and refer as appropriate</li> </ul>
<b>Follow-up</b>	<ul style="list-style-type: none"> <li>Offer referral to perinatal mental health support (e.g. social work, mental health teams, peer support groups, health worker or cultural supports)</li> <li>Liaise with community health practitioners (e.g. general practitioner, midwives, health worker) throughout the perinatal period</li> </ul>

### 2.2 Visiting in-patient mothers and babies

Table 4. Hospital visiting

Aspect	Consideration
<b>Visitor restrictions</b>	<ul style="list-style-type: none"> <li>Limit number of visitors<sup>21,22</sup> to minimise potential for virus spread</li> <li>Hospital visits have been restricted by the Chief Health Officer (in accordance with emergency powers arising from a declared public health emergency)<sup>21</sup></li> <li>No hospital visiting by a person: <ul style="list-style-type: none"> <li>Confirmed as COVID-19 positive</li> <li>Under 16 years of age</li> <li>Who has been asked to self-quarantine</li> <li>Is unwell, particularly with respiratory symptoms</li> </ul> </li> <li>Consider individual circumstances as required (e.g. compassionate needs, cultural safety)</li> </ul>
<b>Information for women</b>	<ul style="list-style-type: none"> <li>Advise women about the need and rationale for visitor restrictions to facilitate advance planning and manage expectations for care</li> </ul>
<b>During labour and birth</b>	<ul style="list-style-type: none"> <li>During labour and birth, recommend one constant support person visiting/present (i.e. not rotating visits between multiple people) consistent with restrictions identified above</li> <li>Where visiting restrictions apply to the support person or the woman (e.g. either or both currently in isolation/quarantine) <ul style="list-style-type: none"> <li>Consider risk and benefit of individual circumstances</li> <li>Support the woman to identify an appropriate support person</li> <li>Requiring the woman to labour and birth without a support person not recommended</li> </ul> </li> </ul>

## 2.3 Home visiting during COVID-19 pandemic (for all women)

Table 5. Home visiting during COVID-19 pandemic

Aspect	Consideration
<b>General principles</b>	<ul style="list-style-type: none"> <li>• Use clinical judgement and consider individual circumstances when determining most appropriate model of healthcare delivery (i.e. is a home visit necessary)               <ul style="list-style-type: none"> <li>○ Hybrid models of care delivery (e.g. combination of telehealth and home visit) may assist in minimising contact duration</li> </ul> </li> <li>• Use advance planning to identify and:               <ul style="list-style-type: none"> <li>○ Prepare for the care likely to be required during the home visit</li> <li>○ Minimise equipment to be taken into the home</li> <li>○ Maintain infection prevention and control standards                   <ul style="list-style-type: none"> <li>▪ Hand hygiene</li> <li>▪ Disposal of consumables</li> <li>▪ Equipment cleaning</li> <li>▪ Physical (social) distancing</li> </ul> </li> </ul> </li> </ul>
<b>Pre-visit assessment</b>	<ul style="list-style-type: none"> <li>• Prior to entering the woman's home, assess the clinical status and social circumstances of the woman and other residents at the home (e.g. by phone, telehealth)</li> <li>• Use standard home visiting risk assessment tools and additionally ask:               <ul style="list-style-type: none"> <li>○ Do any residents have symptoms of COVID-19?</li> <li>○ Are any residents in self-quarantine/isolation?</li> <li>○ Are there additional safety issues for the healthcare provider and/or the woman that may arise/be exacerbated by the COVID-19 pandemic or the home visit (e.g. domestic and family violence, alcohol or substance use, high mobility of household residents)?</li> </ul> </li> <li>• If risk of transmission or safety concerns identified, postpone the home visit               <ul style="list-style-type: none"> <li>○ Reschedule/make alternative arrangements as required</li> </ul> </li> </ul>
<b>During visit</b>	<ul style="list-style-type: none"> <li>• If the woman and other home residents asymptomatic and not in self-isolation/quarantine, personal protective equipment (PPE) (related to COVID-19 transmission) not required               <ul style="list-style-type: none"> <li>○ Refer to Section 3.4 Personal protective equipment</li> </ul> </li> <li>• Maintain physical (social) distancing (1.5 metre from the woman) during the visit where possible (e.g. ask other family members to leave the room during visit)               <ul style="list-style-type: none"> <li>○ Follow standard infection prevention and control recommendations as required for usual care</li> <li>○ Refer to Definitions Standard precautions</li> </ul> </li> </ul>

## 2.4 Specific recommendations for maternity care (for all women)

Table 6. Specific considerations for maternity care

Aspect	Consideration
<b>Antenatal education</b>	<ul style="list-style-type: none"> <li>• Promote access to online antenatal education as the standard and preferred mode of birth               <ul style="list-style-type: none"> <li>○ For example, group/individual sessions via online platforms, static web resources, email contact, support groups, telehealth appointments or mobile phone that can receive MSG documents</li> </ul> </li> </ul>
<b>Antenatal schedule</b>	<ul style="list-style-type: none"> <li>• Assess the individual circumstances of each woman and tailor the number and schedule of antenatal encounters to the essential minimum</li> <li>• Reduce the number of face-to-face encounters and substitute telehealth consultations (if clinically safe to do so)</li> <li>• To avoid additional visitations, schedule/reschedule face-to-face encounters with multiple health care providers, to occur on the same day</li> <li>• If required, assess transport options and/or need for assistance with technology</li> <li>• Refer to Appendix A: Modified schedules for low-risk women during COVID-19</li> </ul>
<b>Routine ultrasound</b>	<ul style="list-style-type: none"> <li>• For guidance on routine ultrasound in the low risk woman (without any pre-existing maternal or fetal comorbidities)<sup>23</sup> <ul style="list-style-type: none"> <li>○ Refer to Appendix A: Modified schedules for low-risk women during COVID-19</li> </ul> </li> <li>• If clinical concerns, use clinical judgement and seek expert advice</li> </ul>
<b>Vaccination</b>	<ul style="list-style-type: none"> <li>• Recommend routine vaccinations for whooping cough and influenza to pregnant women</li> </ul>
<b>Gestational diabetes mellitus (GDM)</b>	<ul style="list-style-type: none"> <li>• Refer to Queensland Clinical Guideline: <i>Gestational Diabetes</i><sup>24</sup> for changes to screening and diagnosis of GDM during COVID-19 pandemic               <ul style="list-style-type: none"> <li>○ Aims to support physical (social) distancing during the COVID-19 pandemic</li> <li>○ These recommendations have been endorsed by the Australian Diabetes in Pregnancy Society (ADIPS)<sup>25</sup></li> </ul> </li> </ul>
<b>Maternal haemoglobin</b>	<ul style="list-style-type: none"> <li>• Optimise haemoglobin prior to birth to minimise morbidity associated with blood loss and the subsequent need for blood products (which may be in short supply during the pandemic)</li> <li>• Refer to Lifeblood (Australian Red Cross) <i>Maternity Blood Management</i> (link available from the <a href="https://www.health.qld.gov.au/qcg">https://www.health.qld.gov.au/qcg</a>)</li> </ul>
<b>Vulnerable women</b>	<ul style="list-style-type: none"> <li>• Women with co-morbidities (e.g. obesity, gestational diabetes, pre-eclampsia) may be at increased risk for severe COVID-19 disease<sup>7</sup> <ul style="list-style-type: none"> <li>○ Seek expert clinical advice early in the pregnancy to plan care</li> <li>○ Refer to the Royal College of Obstetricians <i>Guidance for maternal medicine in the evolving coronavirus (COVID-19) pandemic</i><sup>26</sup></li> </ul> </li> <li>• Aboriginal and/or Torres Strait Islander women, and other vulnerable groups may be more severely impacted               <ul style="list-style-type: none"> <li>○ Involve appropriate cultural supports as required</li> </ul> </li> </ul>

### 3 Risk management

#### 3.1 Risk containment (for all women)

Table 7. Containment and risk minimisation

Aspect	Consideration
<b>Containment</b>	<ul style="list-style-type: none"> <li>Aims to slow the spread of the virus, reduce peak demand on health care services and allow care to be provided to more women and their families during the outbreak<sup>27</sup></li> <li>For women self-identifying with symptoms or confirmed COVID-19:               <ul style="list-style-type: none"> <li>Screen before arrival (e.g. by phone, telehealth)</li> <li>Triage in a location separate from usual admission/assessment routes</li> <li>Provide and recommend use of surgical face mask to woman at face-to-face contact</li> </ul> </li> </ul>
<b>Infection prevention and control</b>	<ul style="list-style-type: none"> <li>Follow Queensland Health recommendations and public alerts for infection prevention and control, isolation, specimen collection and use of personal protective equipment (PPE)</li> <li>Refer to: <a href="https://www.health.qld.gov.au/clinical-practice/guidelines-procedures/novel-coronavirus-qld-clinicians">https://www.health.qld.gov.au/clinical-practice/guidelines-procedures/novel-coronavirus-qld-clinicians</a></li> </ul>
<b>Risk minimisation strategies (for all women)</b>	<ul style="list-style-type: none"> <li>Recommend and inform women and their families about:               <ul style="list-style-type: none"> <li>Hand-hygiene with soap and water for 20 seconds or with alcohol-based hand sanitiser/gel</li> <li>Coughing and sneezing into elbow</li> <li>Physical (social) distancing (stay 1.5 metres from other people) and avoid close contact</li> <li>Using dedicated personal equipment and resources</li> <li>Cleaning and sterilisation of surfaces and equipment</li> <li>Rationale for visitor restrictions (to reduce potential for spread of virus)</li> <li>Importance of risk minimisation strategies for postnatal baby care</li> </ul> </li> </ul>

#### 3.2 Risk assessment

Table 8. Risk assessment

Aspect	Consideration																										
<b>Risk factors</b>	<ul style="list-style-type: none"> <li>Signs and symptoms of acute respiratory infection               <ul style="list-style-type: none"> <li>After exposure: mean incubation 5–6 days, range 1–14 days<sup>5</sup></li> <li>Asymptomatic to very severe manifestation reported<sup>5,28</sup></li> </ul> </li> <li>Close contact with a confirmed or suspected case</li> <li>Interstate or international travel or a cruise ship voyage within last 14 days</li> <li>Disease severity increased by smoking, co-morbidities (e.g. immunosuppressed, obesity)<sup>7</sup></li> </ul>																										
<b>Close contact</b>	<ul style="list-style-type: none"> <li>In the 24 hours before onset of symptoms in a suspected/confirmed case<sup>2</sup>:               <ul style="list-style-type: none"> <li>More than 15 minutes face-to-face contact</li> <li>More than 2 hours in a closed space (including households)</li> </ul> </li> </ul>																										
<b>Frequency* of reported symptoms<sup>5</sup></b>	<table border="1"> <thead> <tr> <th>Sign/Symptom</th> <th>Frequency (%) n=55,924*</th> </tr> </thead> <tbody> <tr> <td>Fever (&gt;38 °C)</td> <td>87.9</td> </tr> <tr> <td>Dry Cough</td> <td>67.7</td> </tr> <tr> <td>Fatigue</td> <td>38</td> </tr> <tr> <td>Sputum production</td> <td>33.4</td> </tr> <tr> <td>Shortness of breath</td> <td>18.6</td> </tr> <tr> <td>Muscle or joint pain</td> <td>14.8</td> </tr> <tr> <td>Sore throat</td> <td>13.9</td> </tr> <tr> <td>Headache</td> <td>13.6</td> </tr> <tr> <td>Chills</td> <td>11.4</td> </tr> <tr> <td>Nausea or vomiting</td> <td>5</td> </tr> <tr> <td>Nasal congestion</td> <td>4.8</td> </tr> <tr> <td>Diarrhoea</td> <td>3.7</td> </tr> </tbody> </table>	Sign/Symptom	Frequency (%) n=55,924*	Fever (>38 °C)	87.9	Dry Cough	67.7	Fatigue	38	Sputum production	33.4	Shortness of breath	18.6	Muscle or joint pain	14.8	Sore throat	13.9	Headache	13.6	Chills	11.4	Nausea or vomiting	5	Nasal congestion	4.8	Diarrhoea	3.7
	Sign/Symptom	Frequency (%) n=55,924*																									
	Fever (>38 °C)	87.9																									
	Dry Cough	67.7																									
	Fatigue	38																									
	Sputum production	33.4																									
	Shortness of breath	18.6																									
	Muscle or joint pain	14.8																									
	Sore throat	13.9																									
	Headache	13.6																									
	Chills	11.4																									
	Nausea or vomiting	5																									
	Nasal congestion	4.8																									
Diarrhoea	3.7																										
*data from non-pregnant confirmed positive cases																											

### 3.3 Testing

Table 9. Testing

Aspect	Consideration
<b>Indications</b>	<ul style="list-style-type: none"> <li>• Follow <u>current</u> Queensland Health recommendations for testing</li> <li>• These are being updated frequently</li> <li>• Available at <a href="https://www.health.qld.gov.au/clinical-practice/guidelines-procedures/novel-coronavirus-qld-clinicians">https://www.health.qld.gov.au/clinical-practice/guidelines-procedures/novel-coronavirus-qld-clinicians</a></li> </ul>
<b>Sample collection</b>	<ul style="list-style-type: none"> <li>• Follow PPE recommendations for specimen collection <ul style="list-style-type: none"> <li>◦ <a href="https://www.health.qld.gov.au/clinical-practice/guidelines-procedures/novel-coronavirus-qld-clinicians">https://www.health.qld.gov.au/clinical-practice/guidelines-procedures/novel-coronavirus-qld-clinicians</a></li> </ul> </li> <li>• Collect a single nasopharyngeal and oropharyngeal swab (use same swab for both sites<sup>29</sup>) <ul style="list-style-type: none"> <li>◦ Use viral transport medium (VTM) or Liquid Amies. Dry swabs not recommended<sup>29</sup></li> </ul> </li> <li>• If productive cough, collect sputum (potentially contains highest viral loads)<sup>29</sup></li> <li>• If confirmed positive COVID-19, collect blood sample (for storage pending serological availability)<sup>29</sup></li> <li>• Include priority status (e.g. unwell/symptomatic) to assist laboratory processing/prioritisation</li> </ul>
<b>Request form</b>	<ul style="list-style-type: none"> <li>• On pathology request form write: <i>Naso &amp; oropharyngeal swab for NCVPCR</i></li> <li>• If suspicion of other respiratory virus (e.g. rhinovirus, influenza) also request GeneXpert test <ul style="list-style-type: none"> <li>◦ Add to pathology request form: <i>fluA&amp;B/RSV</i></li> </ul> </li> <li>• Reserve full respiratory panel (RESPCR) for: <ul style="list-style-type: none"> <li>◦ Those requiring admission <i>or</i></li> <li>◦ Where infection control decisions required (e.g. health workers, vulnerable groups including Aboriginal and/or Torres Strait Islander women)</li> </ul> </li> </ul>
<b>Notifications</b>	<ul style="list-style-type: none"> <li>• COVID-19 is a controlled notifiable condition<sup>3</sup> <ul style="list-style-type: none"> <li>◦ Notifiable on provisional and clinical diagnosis, pathology request and pathological diagnosis</li> </ul> </li> <li>• Notify key healthcare providers of COVID-19 test result including infection control services and frontline staff<sup>3</sup> <ul style="list-style-type: none"> <li>◦ Include other health care providers as recipients of result on request form (e.g. GP)</li> <li>◦ If no GP, recommend the woman contacts a local GP/medical centre to arrange follow-up</li> </ul> </li> </ul>

### 3.4 Personal protective equipment

Table 10. Personal protective equipment

Aspect	Consideration
<b>Standard precautions</b>	<ul style="list-style-type: none"> <li>Follow standard precautions<sup>4</sup> in addition to other transmission precautions               <ul style="list-style-type: none"> <li>Refer to Definitions</li> </ul> </li> <li>Droplet and contact precautions required prior to entering the room of a suspected or confirmed COVID-19 woman or baby</li> </ul>
<b>PPE</b>	<ul style="list-style-type: none"> <li>Droplet and contact precautions consist of<sup>3</sup>:               <ul style="list-style-type: none"> <li>Surgical mask</li> <li>Long-sleeved fluid resistant gown</li> <li>Gloves</li> <li>Eye protection (face shield or goggles)</li> </ul> </li> <li>Airborne and contact precautions consist of<sup>3</sup>:               <ul style="list-style-type: none"> <li>Fit checked P2 or N95 face mask</li> <li>Long sleeved fluid-resistant gown</li> <li>Gloves</li> <li>Eye protection (face shield or goggles)</li> </ul> </li> </ul>
<b>Shoe/shoe cover</b>	<ul style="list-style-type: none"> <li>Wear shoes that are impermeable to liquids<sup>30</sup></li> <li>Recurrent use of shoe covers is not recommended as repeated removal is likely to increase the risk of contamination<sup>30</sup></li> </ul>
<b>Intrapartum</b>	<ul style="list-style-type: none"> <li>Evidence is not yet conclusive about the role of aerosol transmission of SARS-Co-V2<sup>31,32</sup></li> <li>High transmissibility of COVID-19 as a result of confined spaces and proximity to infected persons has been demonstrated<sup>33</sup></li> <li>Consensus view that during labour, airborne and contact precautions are required (as outlined in Table 11. PPE by type of care)               <ul style="list-style-type: none"> <li>By the primary midwife during first stage due to prolonged and sustained contact with the woman</li> <li>By all personnel during second stage due to the potential for aerosol transmission during expulsive maternal efforts</li> </ul> </li> <li>Only essential personnel in birthing room to conserve PPE</li> </ul>

### 3.5 PPE recommendations by care type

The following table provides guidance for PPE when providing care to the woman and baby with suspected or confirmed mild COVID-19 disease. Women with severe disease require airborne and contact precautions.

Table 11. PPE by type of care

PPE recommendation by care type	Droplet and contact	Airborne and contact
Risk assessment	✓	
Specimen collection (mild symptoms)	✓	
Specimen collection (severe symptoms)		✓
Routine inpatient maternity care (antenatal and postnatal)	✓	
Labour (primary midwife with prolonged exposure)		✓
Labour (all other healthcare providers)	✓	
Second and third stage		✓
Birth or procedure in operating theatre (including operative vaginal birth, caesarean section under neuraxial blockade)		✓
Neonatal resuscitation		✓
Well baby co-located with mother	✓	
Baby requiring respiratory support in neonatal unit		✓
Baby not requiring respiratory support in neonatal unit	✓	
All AGP (e.g. maternal or neonatal intubation, ventilation, CPAP, high flow)		✓

### 3.6 Self-quarantine/isolation

Table 12. Self-quarantine/isolation

Aspect	Consideration
<b>Definitions</b>	<ul style="list-style-type: none"> <li>• Self-quarantine               <ul style="list-style-type: none"> <li>○ Used to restrict the movement of a well person who may have been exposed for the period when they could become unwell (duration 14 days for COVID-19)</li> </ul> </li> <li>• Self-isolation               <ul style="list-style-type: none"> <li>○ Used to separate ill people from those who are healthy until they are declared recovered</li> </ul> </li> </ul>
<b>When to recommend</b>	<ul style="list-style-type: none"> <li>• Self-quarantine for 14 days               <ul style="list-style-type: none"> <li>○ If returned from interstate, international or cruise ship travel within previous 14 days, (even if COVID-19 test result negative<sup>2</sup>)</li> <li>○ If close contact with a confirmed or suspected case within previous 14 days</li> </ul> </li> <li>• Self-isolation               <ul style="list-style-type: none"> <li>○ If confirmed positive COVID-19</li> <li>○ Duration as specified in the <i>current Communicable Disease Network Australia Guidelines for Public Health Units</i> (frequent updates) available at <a href="https://www.health.qld.gov.au/clinical-practice/guidelines-procedures/novel-coronavirus-qld-clinicians">https://www.health.qld.gov.au/clinical-practice/guidelines-procedures/novel-coronavirus-qld-clinicians</a></li> </ul> </li> </ul>
<b>Advice for self-quarantine/isolation</b>	<ul style="list-style-type: none"> <li>• Do not               <ul style="list-style-type: none"> <li>○ Go out (e.g. to school work, public areas or use public transport)</li> <li>○ Do not have visitors to the home</li> </ul> </li> <li>• Do               <ul style="list-style-type: none"> <li>○ Return home using personal transport (not public transport or ride sharing options)</li> <li>○ Stay indoors at home</li> <li>○ Separate self from other household members (use own bed, bathroom, towels, crockery and utensils)                   <ul style="list-style-type: none"> <li>▪ Self-quarantine: separation as much as possible</li> <li>▪ Self-isolation: strictly avoid contact, or reside only with other positive cases</li> </ul> </li> <li>○ Ventilate rooms by opening windows</li> <li>○ Avoid contact with all visitors to the home</li> </ul> </li> <li>• If directed by a healthcare provider to leave the house (e.g. attend an appointment) wear a face mask</li> <li>• To contact health professional if any concerns               <ul style="list-style-type: none"> <li>○ Provide contact details including 13HEALTH (13 43 25 84) and for local maternity service</li> </ul> </li> </ul>
<b>Care provision in the home</b>	<ul style="list-style-type: none"> <li>• Avoid face-to-face contact until declared recovered</li> <li>• Resume scheduled healthcare after self-quarantine/isolation complete</li> <li>• If healthcare cannot be delayed, individually assess the need for hospital admission<sup>34</sup></li> <li>• Recommend mother and baby remain co-located in the home during self-quarantine/isolation</li> </ul>
<b>PPE</b>	<ul style="list-style-type: none"> <li>• If face-to-face contact during self-isolation/quarantine is essential, use droplet, contact and standard precautions<sup>3</sup> <ul style="list-style-type: none"> <li>○ Surgical mask, long-sleeved fluid resistant gown, gloves and eye protection (face shield or goggles)</li> </ul> </li> </ul>
<b>Risk minimisation</b>	<ul style="list-style-type: none"> <li>• Provide information about infection prevention and control practices that can prevent transmission of COVID-19<sup>2</sup> <ul style="list-style-type: none"> <li>○ Refer to Table 7. Containment and risk minimisation</li> </ul> </li> <li>• Refer to Queensland Clinical Guideline: Parent information:               <ul style="list-style-type: none"> <li>○ COVID-19 in pregnancy<sup>35</sup></li> <li>○ COVID-19 and breastfeeding<sup>36</sup></li> </ul> </li> </ul>

## 4 In-hospital maternity care (if suspected or confirmed COVID-19)

Table 13. In hospital maternity care

Aspect	Consideration
<b>Retrieval or transfer</b>	<ul style="list-style-type: none"> <li>• Suspected or confirmed COVID-19 alone is not an indication for retrieval or transfer <ul style="list-style-type: none"> <li>○ If transport or retrieval required, inform Retrieval Services Queensland (RSQ) of suspected or confirmed COVID-19 status</li> </ul> </li> <li>• Follow usual protocols/processes/criteria for transfer or retrieval</li> </ul>
<b>On admission</b>	<ul style="list-style-type: none"> <li>• Follow Queensland Health recommendations and public alerts for inpatient infection prevention and control, isolation, specimen collection and PPE use <ul style="list-style-type: none"> <li>○ Available at <a href="https://www.health.qld.gov.au/clinical-practice/guidelines-procedures/novel-coronavirus-qld-clinicians">https://www.health.qld.gov.au/clinical-practice/guidelines-procedures/novel-coronavirus-qld-clinicians</a></li> </ul> </li> <li>• To the extent possible: use single rooms and negative pressure rooms</li> <li>• If cohorting of confirmed cases is required, follow Queensland Health guidance and recommendations for patient placement<sup>3</sup></li> <li>• Alert obstetric/midwifery/neonatal/infectious diseases teams of admission</li> <li>• Review the woman's psychological and emotional needs</li> </ul>
<b>Treatment</b>	<ul style="list-style-type: none"> <li>• Currently no proven antiviral treatment<sup>5</sup></li> <li>• Treatment (e.g. anti-pyrexia medicines, anti-diarrheal medicines, intensive care unit admission) is directed by signs and symptoms, and severity of illness<sup>37</sup></li> <li>• Monitor and maintain fluid and electrolyte balance<sup>37</sup></li> <li>• Minimise maternal hypoxia <ul style="list-style-type: none"> <li>○ Oxygen therapy as indicated<sup>38</sup> to maintain target SpO<sub>2</sub> of 92–95%<sup>39</sup></li> <li>○ Use PPE as recommended for aerosol generating procedures (AGP)</li> </ul> </li> <li>• Consult with infectious diseases/microbiology regarding empiric antibiotic therapy for superimposed bacterial pneumonia<sup>37</sup></li> <li>• In the current absence of specific treatment recommendations, refer to <i>SOMANZ guidelines for investigation and management of sepsis in pregnancy</i><sup>40</sup> noting that aggressive fluid management is <u>not</u> recommended for COVID-19</li> </ul>
<b>Venous thromboembolism (VTE) risk</b>	<ul style="list-style-type: none"> <li>• For women with suspected or confirmed COVID-19, consider VTE prophylaxis (antenatal and postpartum) even in the absence of other risk factors<sup>34</sup></li> <li>• Data is limited, especially in pregnant/postpartum women<sup>41</sup> <ul style="list-style-type: none"> <li>○ Pregnancy is a state of increased risk for VTE<sup>42</sup></li> <li>○ Patients with COVID-19 reported to have an additional procoagulant state compared to other hospitalized patients, including activation of coagulation through various infectious and inflammatory mechanisms<sup>43</sup></li> <li>○ Reduced mobility resulting from self-isolation at home or from admission may also increase risk<sup>34</sup></li> </ul> </li> <li>• Refer to Queensland Clinical Guideline: <i>Venous thromboembolism prophylaxis in pregnancy and the puerperium</i><sup>42</sup></li> </ul>



## 4.1 In-hospital antenatal care (if confirmed or suspected COVID-19)

Table 14. Antenatal care while inpatient

Aspect	Consideration
<b>Clinical surveillance</b>	<ul style="list-style-type: none"> <li>In addition to usual maternal and fetal antenatal observations, monitor SpO<sub>2</sub> <ul style="list-style-type: none"> <li>Maintain index of suspicion for bacterial pneumonia</li> </ul> </li> <li>Fetal surveillance as clinically indicated</li> <li>Delay investigations/procedures that require the woman to be transported out of isolation whenever it is clinically safe</li> </ul>
<b>Medical imaging</b>	<ul style="list-style-type: none"> <li>Do not delay necessary medical imaging because of concerns about fetal exposure<sup>37</sup> <ul style="list-style-type: none"> <li>Apply radiation shield over the gravid uterus</li> </ul> </li> <li>Ultrasound scan for fetal wellbeing as indicated and after resolution of acute symptoms</li> <li>If positive COVID-19 result occurs in first trimester, consider a detailed morphology scan at 18–24 weeks <ul style="list-style-type: none"> <li>Currently no data about the risk of congenital malformation with COVID-19 infection acquired in first or second trimester<sup>44</sup></li> <li>In the setting of maternal fever in general, there is mixed data about the risk of congenital abnormalities during embryogenesis<sup>45-48</sup></li> </ul> </li> </ul>
<b>Antenatal corticosteroids</b>	<ul style="list-style-type: none"> <li>Currently insufficient evidence to alter usual indications/recommendations when given for fetal lung maturity<sup>34</sup> <ul style="list-style-type: none"> <li>Mixed reports about outcomes, with design limitations affecting generalisability to administration for fetal lung maturity<sup>49,50</sup></li> </ul> </li> <li>For women with severe COVID-19 disease requiring ICU admission or ventilation, consider individual circumstances and consult with multi-disciplinary experts</li> </ul>
<b>Magnesium sulfate</b>	<ul style="list-style-type: none"> <li>No evidence to alter usual indications/recommendations <ul style="list-style-type: none"> <li>Consider need for conservative fluid management with COVID-19</li> </ul> </li> </ul>
<b>Tocolytics</b>	<ul style="list-style-type: none"> <li>Nifedipine may be beneficial in COVID-19 due to similarities between efficacy in treatment of high altitude pulmonary oedema and lung manifestations of COVID-19<sup>51</sup></li> <li>NSAID (e.g. indomethacin) use in setting of COVID-19 has raised concern, however there is no data to suggest use should be altered at this time<sup>52</sup></li> <li>Avoid betamimetics in women with COVID-19 as may exacerbate maternal hypotension, tachycardia and pulmonary oedema<sup>49</sup></li> </ul>

## 4.2 Labour and birth (if suspected or confirmed COVID-19)

Table 15. Labour and birth

Aspect	Consideration
<b>Mode and setting</b>	<ul style="list-style-type: none"> <li>• A positive COVID-19 result <i>without other indications</i> is not an indication to expedite birth</li> <li>• Decision for mode of birth not influenced by positive COVID-19 result (unless urgent birth indicated)<sup>53</sup></li> <li>• Support the principles of normal birth<sup>54</sup> <ul style="list-style-type: none"> <li>○ Refer to Queensland Clinical Guideline: <i>Normal birth</i></li> </ul> </li> <li>• Use a negative pressure room (if possible) for labour and birth</li> <li>• Inform obstetric consultant and anaesthetic, theatre and neonatal teams of admission to birth suite</li> </ul>
<b>Caesarean section</b>	<ul style="list-style-type: none"> <li>• If elective caesarean has been planned, individually assess urgency</li> <li>• Avoid general anaesthetic unless necessary for standard indications as intubation is an AGP</li> </ul>
<b>Water immersion/birth</b>	<ul style="list-style-type: none"> <li>• No evidence that water immersion is contraindicated<sup>53</sup></li> <li>• Water birth not recommended as SARS-COV-2 has been detected in stools<sup>12-14</sup> and this may pose a risk to the baby</li> <li>• Consider the potential for loss of PPE integrity during emergency procedures and/or evacuation from water</li> </ul>
<b>Fetal monitoring</b>	<ul style="list-style-type: none"> <li>• Discuss the options for fetal monitoring in labour with women</li> <li>• Recommend continuous electronic fetal monitoring as fetal distress has been reported<sup>10</sup></li> <li>• Avoid fetal scalp electrode (FSE) application and fetal blood sampling (FBS) until further information available <ul style="list-style-type: none"> <li>○ If FBS or FSE is considered, weigh the possible (small but unquantifiable) risk of fetal transmission against known benefits of improved assessment of fetal wellbeing<sup>55</sup></li> </ul> </li> </ul>
<b>Neuraxial blockade</b>	<ul style="list-style-type: none"> <li>• No evidence that neuraxial blockade is contraindicated in the presence of COVID-19</li> <li>• Recommend neuraxial blockade before/early in labour to minimise need for general anaesthesia if urgent birth required<sup>34</sup> (intubation is considered an AGP)</li> </ul>
<b>Nitrous oxide</b>	<ul style="list-style-type: none"> <li>• Currently insufficient and conflicting information about cleaning, filtering and AGP potential in the setting of COVID-19<sup>34,56</sup></li> <li>• For reasons of healthcare provider protection, avoid use by women with suspected or confirmed COVID-19</li> <li>• Consider the possibility that asymptomatic women (i.e. not known to COVID-19 positive) may request use during labour</li> <li>• If nitrous oxide is offered, recommend face mask rather than mouthpiece and use the following circuits recommended by Queensland Health Biomedical Technology Services<sup>57</sup>: <ul style="list-style-type: none"> <li>○ Where a scavenger system is available, the Equinox® Advantage Analgesia Circuit–MC/4003</li> <li>○ Where a scavenger system is not available, the Equinox® Advantage Analgesia Circuit–MC/4001</li> <li>○ Refer to Appendix B: Recommended nitrous oxide circuits</li> </ul> </li> </ul>
<b>Intrapartum care</b>	<ul style="list-style-type: none"> <li>• Routine maternal observations including oxygen saturations<sup>34</sup></li> <li>• No evidence that delayed cord clamping increases risk of infection to the newborn<sup>34</sup></li> <li>• Manage placental tissue as per usual infectious human tissue protocols <ul style="list-style-type: none"> <li>○ Discuss restrictions with women prior to birth to assist management of expectation for care (e.g. if the woman was intending to bury/take the placenta home)</li> </ul> </li> </ul>
<b>Clinical emergencies</b>	<ul style="list-style-type: none"> <li>• Donning of PPE takes time, therefore to facilitate a rapid response to a clinical emergency, consider: <ul style="list-style-type: none"> <li>○ Neuraxial blockade early in labour (to avoid need for general anaesthetic)</li> <li>○ Lowering the threshold for escalation of clinical concerns</li> <li>○ Early notification to operating room team (e.g. if PPH)</li> </ul> </li> </ul>

### 4.3 Postnatal care (if suspected or confirmed COVID-19)

Table 16. Postnatal care

Aspect	Consideration
<b>Co-location of mother and baby</b>	<ul style="list-style-type: none"> <li>• Co-location of well mother and well baby is recommended               <ul style="list-style-type: none"> <li>◦ Determine need on individual basis considering for example, disease severity, parental preferences, psychological wellbeing, test results, local capacity, other clinical criteria<sup>58</sup></li> </ul> </li> <li>• Support vigilant risk minimisation strategies (e.g. hand hygiene, use of face mask) during feeding and other close mother-baby interactions</li> </ul>
<b>Risk minimisation</b>	<ul style="list-style-type: none"> <li>• Provide information and education on strategies to use during usual mother-baby interactions (e.g. skin to skin, holding, cuddling, nappy change, feeding)               <ul style="list-style-type: none"> <li>◦ Refer to Table 7. Containment and risk minimisation</li> </ul> </li> <li>• Discuss risks and benefits of close contact versus postnatal separation with parents<sup>58</sup> (including discharge home of well baby if mother requires continued in-hospital care)</li> <li>• No evidence to support washing of maternal or baby skin before initial contact or breastfeeding as a risk minimisation strategy</li> <li>• Consult with clinical experts as required</li> </ul>
<b>Feeding choice</b>	<ul style="list-style-type: none"> <li>• Provide usual support for maternal feeding preferences</li> <li>• Breastfeeding not contraindicated               <ul style="list-style-type: none"> <li>◦ No detectable viral DNA found in breast milk to date<sup>10</sup></li> </ul> </li> <li>• Provide dedicated equipment<sup>58</sup> and follow usual sterilisation standards for both breastfeeding equipment (e.g. breast pump) and for infant formula preparation and feeding equipment</li> </ul>
<b>Expressed breast milk (EBM)<sup>59</sup></b>	<ul style="list-style-type: none"> <li>• Support and encourage mother to express breastmilk (if feeding preference)</li> <li>• Instruct and support adherence to infection prevention and control measures               <ul style="list-style-type: none"> <li>◦ Hand hygiene</li> <li>◦ Equipment cleaning and sterilisation</li> <li>◦ Wearing of face mask (as risk of transmission is unknown)</li> <li>◦ Wipe outside container of EBM with a disinfectant wipe and place/transfer in specimen bag</li> </ul> </li> <li>• Milk bank: pasteurisation destroys other coronaviruses<sup>60</sup>, but it is unknown if this applies to SARS-CoV-2               <ul style="list-style-type: none"> <li>◦ May affect supply or availability of pasteurised donor human milk</li> </ul> </li> </ul>
<b>Discharge</b>	<ul style="list-style-type: none"> <li>• Consider usual discharge criteria</li> <li>• Inform the woman about requirements for completing self-isolation/quarantine (if not completed before discharge)</li> <li>• If Aboriginal and Torres Strait Islander women, their babies and/or support person are returning to defined restricted areas under the Human Biosecurity Act:               <ul style="list-style-type: none"> <li>◦ Two weeks quarantine required to gain Human Biosecurity Officer approval and Local Council permit prior to being able to return to home communities</li> <li>◦ Involve local cultural supports (e.g. health worker, Aboriginal and Torres Strait Islander Medical Services) to facilitate delivery of clinical and psycho-social postpartum care during self-isolation/quarantine</li> </ul> </li> <li>• Refer to Appendix A: Modified schedules for low-risk women during COVID-19</li> </ul>

## 5 Newborn care

For babies born to mothers who are NOT suspected or confirmed COVID-19, provide usual recommended newborn care.

### 5.1 General principles (for all babies)

Table 17. General principles

Aspect	Consideration
<b>Transmission</b>	<ul style="list-style-type: none"> <li>• Maintain high index of suspicion for signs of sepsis/unwell baby</li> <li>• No cases of vertical transmission have been confirmed<sup>10,61,62</sup> but the possibility has not been excluded               <ul style="list-style-type: none"> <li>◦ Refer to Section 1.1 Background</li> </ul> </li> <li>• Babies are at risk of infection from a mother's respiratory secretions after birth<sup>9,62,63</sup></li> <li>• Perinatal exposure may be possible via maternal stool<sup>12-14</sup></li> </ul>
<b>Organisation of neonatal unit areas<sup>59</sup></b>	<ul style="list-style-type: none"> <li>• If possible, identify three separate areas for care within the neonatal unit (special care and intensive care units)</li> <li>• One each for babies:               <ul style="list-style-type: none"> <li>◦ With proven COVID-19</li> <li>◦ Suspected COVID-19/close contact</li> <li>◦ No risk or suspicion of COVID-19</li> </ul> </li> <li>• If separate areas not possible, nurse proven COVID-19 babies in an area separate from other babies</li> <li>• Nurse babies suspected or confirmed COVID-19 in an incubator</li> </ul>
<b>Principles of visitor management</b>	<ul style="list-style-type: none"> <li>• Refer to Table 4. Hospital visiting, for details of hospital visitor restrictions               <ul style="list-style-type: none"> <li>◦ These apply to the mother and partner or nominated support person</li> </ul> </li> <li>• Restrict visitor numbers and duration of visit to all babies               <ul style="list-style-type: none"> <li>◦ Follow local protocols for implementation</li> <li>◦ Recommendation: mother and one dedicated/consistent nominated support person (e.g. partner or close family member)</li> <li>◦ Consider individual circumstances when determining visitor restrictions (e.g. compassionate needs)</li> </ul> </li> <li>• Facilitate use of video to mitigate loss of family contact<sup>64</sup></li> </ul>
<b>Early discharge</b>	<ul style="list-style-type: none"> <li>• If discharge occurs prior to 48 hours of age (with or without completion of neonatal screening test (NNST)) perform NNST at 14 days of age to ensure maximum chance of disease detection</li> <li>• Notify GP if follow-up actions required</li> </ul>

## 5.2 Risk management (baby of suspected or confirmed COVID-19 mother)

Table 18. Risk management

Aspect	Consideration
<b>Risk assessment</b>	<ul style="list-style-type: none"> <li>• A baby born to a mother with suspected or confirmed COVID-19 is considered a close contact of the mother (even if separated from the mother at birth) and requires 14 days of quarantine and infection prevention and control precautions               <ul style="list-style-type: none"> <li>○ This is irrespective of any subsequent negative test result for the baby within the 14 days of quarantine</li> <li>○ Baby can be co-located with mother (both in quarantine)</li> <li>○ If the mother is subsequently confirmed negative for COVID-19, the baby can be released from quarantine precautions</li> </ul> </li> <li>• Refer to Section 3.5 PPE recommendations by care type</li> </ul>
<b>Well term baby and well mother</b>	<ul style="list-style-type: none"> <li>• Baby is well (term or near-term gestation) and mother is well               <ul style="list-style-type: none"> <li>○ Co-locate with mother in a single room OR</li> <li>○ Discharge home</li> <li>○ PPE: Droplet and contact precautions</li> </ul> </li> </ul>
<b>Unwell baby without respiratory support</b>	<ul style="list-style-type: none"> <li>• Baby requiring neonatal unit admission without respiratory support               <ul style="list-style-type: none"> <li>○ Single room</li> <li>○ Closed incubator/cot</li> <li>○ PPE: Droplet and contact precautions</li> </ul> </li> </ul>
<b>Unwell baby with respiratory support</b>	<ul style="list-style-type: none"> <li>• Baby requiring neonatal unit admission with respiratory support (or critically unwell and likely to require respiratory support)               <ul style="list-style-type: none"> <li>○ Negative pressure room (if available)</li> <li>○ Closed incubator/cot</li> <li>○ PPE: Airborne and contact precautions</li> </ul> </li> </ul>
<b>Baby with confirmed COVID-19</b>	<ul style="list-style-type: none"> <li>• Babies are known to be significant shedders of respiratory viruses<sup>65</sup></li> <li>• A confirmed COVID-19 positive baby may or may not require care within neonatal unit</li> <li>• Follow PPE precautions appropriate to clinical situation as above</li> </ul>

### 5.3 Initial care (baby of suspected or confirmed COVID-19 mother)

Table 19. Baby of suspected/positive COVID-19 mother

Aspect	Consideration
<b>Neonatal team attendance at birth</b>	<ul style="list-style-type: none"> <li>• Assign a dedicated neonatal team member to attend the birth<sup>66</sup> according to usual clinical indications (i.e. not required for reason of suspected or confirmed COVID-19 mother alone)</li> <li>• To minimise healthcare provider exposure               <ul style="list-style-type: none"> <li>○ Consider if neonatal stabilisation/resuscitation in a room outside of the birthing room/theatre is appropriate</li> <li>○ Experienced/senior clinician to attend in the first instance</li> </ul> </li> <li>• If intubation not anticipated, droplet and contact precautions recommended</li> <li>• If intubation or other AGP anticipated, use airborne and contact precautions</li> </ul>
<b>Resuscitation</b>	<ul style="list-style-type: none"> <li>• Minimise equipment on resuscitation cot to essential items               <ul style="list-style-type: none"> <li>○ Place extra equipment anticipated to be required in sealed plastic bags</li> </ul> </li> <li>• The use of additional barriers (e.g. placing baby under plastic sheet) for the purpose of COVID-19 infection control, is not currently supported by the Australian Society of Anaesthetists as may inadvertently increase the risk of transmission<sup>1</sup> <ul style="list-style-type: none"> <li>○ Follow usual indications for the use of plastic/polyethylene bags during neonatal resuscitation</li> </ul> </li> <li>• Follow standard neonatal resuscitation recommendations               <ul style="list-style-type: none"> <li>○ Refer to Queensland Clinical Guideline: <i>Neonatal resuscitation</i><sup>67</sup></li> </ul> </li> <li>• Refer to Section 5.4 Respiratory support management (if COVID-19 suspected or confirmed)</li> </ul>
<b>Admission to neonatal unit</b>	<ul style="list-style-type: none"> <li>• COVID-19 positive mother (i.e. no other neonatal criteria), is not itself an indication for admission to a neonatal unit<sup>68</sup></li> <li>• Perform clinical assessment after birth as per usual assessment protocols</li> <li>• Assess if required care can safely be provided during co-location with mother (preferred option<sup>68</sup>)</li> <li>• Follow usual clinical criteria, processes and protocols relevant to admission</li> <li>• Refer to Table 18. Risk management</li> </ul>
<b>Transport</b>	<ul style="list-style-type: none"> <li>• Where feasible, transport baby in a closed system between locations in the facility</li> <li>• Plan the transport route in advance</li> <li>• Consider use of a<sup>59</sup>:               <ul style="list-style-type: none"> <li>○ Dedicated elevator</li> <li>○ “Runner” to open doors and clear obstacles</li> </ul> </li> </ul>

## 5.4 Respiratory support management (if COVID-19 suspected or confirmed)

Table 20. respiratory support management

Aspect	Consideration
<b>Aerosol generating procedures (AGP)</b>	<ul style="list-style-type: none"> <li>Evidence for risk of aerosol transmission arising from neonatal respiratory care is limited</li> <li>To maximise healthcare provider protection, this guideline currently includes the following procedures as AGP<sup>64</sup> (but not necessarily limited to):               <ul style="list-style-type: none"> <li>Intubation, extubation and related procedures (e.g. manual ventilation)</li> <li>Open suctioning of respiratory tract (including upper respiratory tract)</li> <li>Less invasive surfactant administration (LISA)</li> <li>Non-invasive ventilation (e.g. continuous positive airway pressure (CPAP))</li> <li>Tracheotomy/tracheostomy procedures (insertion, open suctioning, or removal)</li> <li>High frequency oscillatory ventilation (HFOV)</li> <li>High flow nasal oxygen</li> </ul> </li> </ul>
<b>Risk minimisation</b>	<ul style="list-style-type: none"> <li>Nurse babies requiring respiratory support in an incubator</li> <li>If available, in a negative pressure room</li> <li>Use airborne and contact PPE</li> <li>Place a high efficiency hydrophobic HME filter in the expiratory line of the breathing circuit               <ul style="list-style-type: none"> <li>Refer to Appendix C: Appendix C: General principles during initial stabilisation</li> <li>Follow local protocols/recommendations for specific equipment requirements</li> </ul> </li> <li>If used in current practice, use in-line suction with endotracheal tubes<sup>30</sup></li> <li>Avoid bubble CPAP</li> <li>Avoid use of nebulised agents (salbutamol, saline)<sup>30</sup> although conflicting information about whether it is an AGP<sup>64</sup></li> </ul>

## 5.5 Newborn COVID-19 testing

Table 21. Newborn testing

Aspect	Consideration
<b>Context</b>	<ul style="list-style-type: none"> <li>Overseas expert clinicians have expressed concern about low sensitivity of the test (i.e. number of false negatives), but less concern with the specificity of the test (false positives)<sup>69</sup>, therefore a positive result may be more clinically informative than a negative result</li> </ul>
<b>Routine testing</b>	<ul style="list-style-type: none"> <li>Routine testing not recommended for asymptomatic baby born to mother with suspected or confirmed COVID-19</li> <li>Refer to indications for testing (below), use clinical judgement, and follow local protocols/expert advice</li> </ul>
<b>Indications for testing<sup>2</sup></b>	<ul style="list-style-type: none"> <li>Symptomatic baby (e.g. fever, acute respiratory illness) not otherwise explained in a baby:               <ul style="list-style-type: none"> <li>With a COVID-19 positive caregiver (e.g. mother, household contact or healthcare provider)</li> <li>Where transmission is suspected due to environmental setting (e.g. ward cluster)</li> </ul> </li> <li>Suspected congenital infection or vertical transmission (e.g. congenital pneumonia) in baby born to mother with suspected/confirmed COVID-19</li> </ul>
<b>Timing of test (if indicated)</b>	<ul style="list-style-type: none"> <li>If indicated (refer above), test 12–24 hours after birth (earlier is likely to reflect maternal infection)</li> <li>Undertake subsequent testing as indicated</li> </ul>
<b>Sample collection</b>	<ul style="list-style-type: none"> <li>Collect nasopharyngeal and oropharyngeal swab               <ul style="list-style-type: none"> <li>Single swab for both sites</li> <li>If intubated, collect endotracheal aspirate</li> </ul> </li> <li>Individually assess and seek expert advice as to whether other specimens (e.g. faeces, blood) should be tested and/or stored for later testing</li> <li>Refer to Table 9. Testing</li> </ul>

## 5.6 Discharge (following suspected or confirmed COVID-19)

This section applies to the baby born to a mother with suspected or confirmed COVID-19, and/or to the baby who is suspected or confirmed COVID-19 after birth.

Table 22. Discharge

Aspect	Consideration
<b>Criteria for discharge</b>	<ul style="list-style-type: none"> <li>• Consider usual criteria for readiness for discharge (e.g. wellness, laboratory test results)</li> <li>• An appropriate caregiver has been identified</li> <li>• For discharge home, a negative test is not required prior to release from isolation</li> </ul>
<b>Appropriate caregivers</b>	<ul style="list-style-type: none"> <li>• The mother who is well enough and meets criteria for discharge</li> <li>• Alternate caregiver determined on a case by case basis who               <ul style="list-style-type: none"> <li>○ Has no respiratory symptoms</li> <li>○ Is otherwise considered appropriate/safe care giver for baby</li> </ul> </li> </ul>
<b>Discharge prior to 14 days</b>	<ul style="list-style-type: none"> <li>• If discharged prior to completion of 14 days of precautions               <ul style="list-style-type: none"> <li>○ Continue clinical monitoring until 14 days of precautions is complete</li> </ul> </li> <li>• Consider local capacity when determining how clinical monitoring is to be undertaken after discharge (e.g. telehealth services, home visiting, GP)</li> </ul>
<b>Post discharge</b>	<ul style="list-style-type: none"> <li>• Provide post discharge advice about indications for readmission and possible course of disease<sup>70</sup> <ul style="list-style-type: none"> <li>○ Most commonly reported are respiratory symptoms requiring readmission one to three weeks after discharge</li> </ul> </li> <li>• Delay routine follow-up as required (e.g. hearing screen)</li> <li>• Advise GP of the follow-up actions required (e.g. NNST)</li> <li>• Refer to Child Health Services as per usual process</li> </ul>



## References

1. Australian Society of Anaesthetists (ASA). Anaesthesia and caring for patients during the COVID-19 outbreak. [Internet]. 2020 March 27 [cited 2020 April 06]. Available from: <https://asa.org.au>.
2. Communicable Diseases Network Australia. Coronavirus Disease 2019 (COVID-19) CDNA National Guidelines for Public Health Units v2.4. [Internet]. 2020 March 26 [cited 2020 April 02]. Available from: [https://www1.health.gov.au/internet/main/publishing.nsf/Content/7A8654A8CB144F5FCA2584F8001F91E2/\\$File/interim-COVID-19-SoNG-v2.0.pdf](https://www1.health.gov.au/internet/main/publishing.nsf/Content/7A8654A8CB144F5FCA2584F8001F91E2/$File/interim-COVID-19-SoNG-v2.0.pdf).
3. Queensland Health. Interim infection prevention and control guidelines for the management of COVID-19 in healthcare settings Version 1.10. [Internet]. 2020 March 27 [cited 2020 April 04]. Available from: <https://www.health.qld.gov.au/clinical-practice/guidelines-procedures/novel-coronavirus-qld-clinicians>.
4. Australian Government, National Health and Medical Research Council, Australian Commission on Safety and Quality in Health Care. Australian Guidelines for the Prevention and Control of Infection in Healthcare. [Internet]. 2019 [cited 2020 April 03]. Available from: <https://www.nhmrc.gov.au>.
5. WHO-China Joint Mission on Coronavirus Disease 2019 (COVID-19). Report of the WHO-China Joint Mission on Coronavirus Disease 2019 (COVID-19). [Internet]. 2020 February 16-24 [cited 2020 March 16]. Available from: <https://www.who.int>.
6. Queensland Health. Personal protective equipment: information for general practices. [Internet]. 2020 February 28 [cited 2020 March 23]. Available from: <https://www.health.qld.gov.au/clinical-practice/guidelines-procedures/novel-coronavirus-qld-clinicians>.
7. Zaigham M, Andersson O. Maternal and perinatal outcomes with COVID-19: a systematic review of 108 pregnancies. *Acta Obstetrica et Gynecologica Scandinavica*. [Internet]. 2020 [cited 2020 April 10]. Available from: <https://doi.org/10.1111/aogs.13867>.
8. Zeng H, Xu C, Fan J, Tang Y, Deng Q, Zhang W, et al. Antibodies in infants born to mothers with COVID-19 pneumonia. *JAMA* 2020.
9. Dong L, Tian J, He S, Zhu C, Wang J, Liu C, et al. Possible vertical transmission of SARS-CoV-2 from an infected mother to her newborn. *JAMA*. [online]. 2020 March 26 [cited 2020 April 03]; DOI:10.1001/jama.2020.4621.
10. Chen H, Guo J, Wang C, Luo F, Yu X, Zhang W, et al. Clinical characteristics and intrauterine vertical transmission potential of COVID-19 infection in nine pregnant women: a retrospective review of medical records. *The Lancet*. [Internet]. 2020 February 12 [cited 2020 March 16]; DOI:10.1016/S0140-6736(20)30360-3.
11. Qiu L, Liu X, Xiao M, Xie J, Cao W, Liu Z, et al. SARS-CoV-2 is not detectable in the vaginal fluid of women with severe COVID-19 infection. *Clinical Infectious Diseases* 2020.
12. Gu J, Han B, Wang J. COVID-19: Gastrointestinal manifestations and potential fecal-oral transmission. *Gastroenterology*. [online]. 2020 [cited 2020 April 02]; DOI:10.1053/j.gastro.2020.02.054
13. Tian Y, Rong L, Nian W, He Y. Review article: gastrointestinal features in COVID-19 and the possibility of faecal transmission. *Aliment Pharmacol Ther*. [Internet]. 2020 [cited 2020 March 29]; DOI:10.1111/apt.15731.
14. Xiao F, Tang M, Zheng X, Liu Y, Li X, Shan H. Evidence for gastrointestinal infection of SARS-CoV-2. *Gastroenterology* 2020.
15. Liang H, Acharya G. Novel corona virus disease (COVID-19) in pregnancy: What clinical recommendations to follow? *Acta Obstet Gynecol Scand* 2020;00:1-4.
16. Breslin N, Baptiste C, Gyamfi-Bannerman C, Miller R, Martinez R, Bernstein K, et al. COVID-19 infection among asymptomatic and symptomatic pregnant women: two weeks of confirmed presentations to an affiliated pair of New York City hospitals. *American Journal of Obstetrics & Gynecology MFM*. [Internet]. 2020 April 09 [cited 2020 April 10]. Available from: <https://doi.org/10.1016/j.ajogmf.2020.100118>.
17. Li N, Han L, Peng M, Lv Y, Ouyang Y, Liu K, et al. Maternal and neonatal outcomes of pregnant women with COVID-19 pneumonia: a case-control study. *Clinical Infectious Diseases*. 2020 [cited 2020 April 10]. Available from: <https://doi.org/10.1093/cid/ciaa352>.
18. Wu Y-T, Zhang Cea. Perinatal Depression of Women Along with 2019 Novel Coronavirus Breakout in China. [Internet]. 2020 February 17 [cited 2020 March 06]. Available from: <https://ssrn.com/abstract=3539359> DOI:<http://dx.doi.org/10.2139/ssrn.3539359>
19. Black B, Mackay G. Covid-19 and reproductive health: What can we learn from previous epidemics? *BMJ opinion*. [Internet]. 2020 March 19 [cited 2020 March 25]. Available from: <https://blogs.bmj.com/bmj/2020/03/19/covid-19-and-reproductive-health-what-can-we-learn-from-previous-epidemics>
20. Queensland Clinical Guidelines. Standard care. Guideline No. MN18.50-V1-R23. [Internet]. Queensland Health. 2018. [cited 2020 March 23]. Available from: <https://www.health.qld.gov.au/qcg>
21. Queensland Government. Chief Health Officer public health directions - hospital visitors direction. [Internet]. 2020 March 26 [cited 2020 April 03]. Available from: <https://www.health.qld.gov.au/system-governance/legislation/cho-public-health-directions-under-expanded-public-health-act-powers/hospital-visitors-direction>
22. The Royal Australian and New Zealand College of Obstetricians and Gynaecologists. Statement on support persons. [Internet]. 2020 March 31 [cited 2020 April 03]. Available from: <https://ranzcog.edu.au>.
23. Abu-Rustum R, Akolekar R, Sotiriadis A, Salomon L, Da Silva Costa F, Wu Q, et al. ISUOG Consensus Statement on organization of routine and specialist obstetric ultrasound services in the context of COVID-19. *Ultrasound Obstet Gynecol*. [Internet]. 2020 March 31 [cited 2020 April 03]; DOI:<https://doi.org/10.1002/uog.22029>.
24. Queensland Clinical Guidelines. Gestational diabetes. Guideline No. MN15.33-V1-R20. [Internet]. Queensland Health. 2015. [cited 2020 March 25]. Available from: <https://www.health.qld.gov.au/qcg>
25. Australian Diabetes in Pregnancy Society (ADIPS). Diagnostic testing for gestational diabetes mellitus (gdm) during the covid 19 pandemic: antenatal and postnatal testing advice. [Internet]. 2020 April 07 [cited 2020

- April 08]. Available from: [https://www.adips.org/documents/COVID19-WITHQLDGUIDELINES0704201150ADIPSADSADEADAupdated\\_000.pdf](https://www.adips.org/documents/COVID19-WITHQLDGUIDELINES0704201150ADIPSADSADEADAupdated_000.pdf).
26. Royal College of Obstetricians and Gynaecologists (RCOG). Guidance for maternal medicine in the evolving coronavirus (COVID-19) pandemic V4. [Internet]. 2020 March 30 [cited 2020 April 03]. Available from: <https://www.rcog.org.uk>.
27. Qualls N, Levitt A, Kanade N, et al. Community Mitigation Guidelines to Prevent Pandemic Influenza — United States, 2017. *MMWR Recomm Rep* 2017;66(No. RR-1):1–34. [Internet]. 2017 [cited 2020 March 06]. Available from: <https://www.cdc.gov/mmwr> DOI:10.15585/mmwr.rr6601a1.
28. Liu Y, Chen H, Tang K, Guo Y. Clinical manifestations and outcome of SARS-CoV-2 infection during pregnancy. *Infection*. [Internet]. 2020 February 27 [cited 2020 April 02]; DOI:10.1016/j.jinf.2020.02.028.
29. Department of Health. PHLN guidance on laboratory testing for SARS-CoV-2 version 1.3. [Internet]. 2020 March 13 [cited 2020 March 18]. Available from: <https://www.health.gov.au/sites/default/files/documents/2020/03/phln-guidance-on-laboratory-testing-for-sars-cov-2-the-virus-that-causes-covid-19.pdf>.
30. The Australian and New Zealand Intensive Care Society (ANZICS). The Australian and New Zealand Intensive Care Society (ANZICS) COVID-19 Guidelines (V1). [Internet]. 2020 March 16 [cited 2020 April 06]. Available from: <https://www.anzics.com.au>.
31. Asadi S, Bouvier N, Wexler A, Ristenpart D. The coronavirus pandemic and aerosols: does COVID-19 transmit via expiratory particles? *Aerosol Science and Technology*. [Internet]. 2020 April 03 [cited 2020, April 12]. Available from: <https://doi.org/10.1080/02786826.2020.1749229>.
32. van Doremalen N, Bushmaker T, Morris DH, Holbrook MG, Gamble A, Williamson BN, et al. Aerosol and Surface Stability of SARS-CoV-2 as Compared with SARS-CoV-1. *New England Journal of Medicine* 2020.
33. Dietz L, Horve PF, Coil D, Fretz M, Van Den Wymelenberg K. 2019 Novel coronavirus (COVID-19) outbreak: a review of the current literature and built environment (BE) considerations to reduce transmission. *Preprints* 2020, 2020030197. [Internet]. 2020 [cited 2020 April 02]; DOI:10.20944/preprints202003.0197.v1.
34. Royal College of Obstetricians and Gynaecologists (RCOG). Coronavirus (COVID-19) infection in pregnancy: information for healthcare professionals V8. [Internet]. 2020 April 17 [cited 2020 March 30]. Available from: <https://www.rcog.org.uk>.
35. Queensland Clinical Guidelines. COVID-19 in pregnancy. Guideline No. C20.63-1-V1-R25. [Internet]. Queensland Health. 2020. [cited 2020 March 26]. Available from: <https://www.health.qld.gov.au/qcg>
36. Queensland Clinical Guidelines. COVID-19 and breastfeeding. Guideline No. C20.63-2-V1-R25. [Internet]. Queensland Health. 2020. [cited 2020 March 26]. Available from: <https://www.health.qld.gov.au/qcg>
37. Poon L, Yang H, Lee JCS, Copel J, Leung T, Zhang Y, et al. ISUOG interim guidance on 2019 novel coronavirus infection during pregnancy and puerperium: information for healthcare professionals. [Epub ahead of print]. *Ultrasound Obstet Gynecol* 2020 March 11.
38. Chua MSQ, Lee JCS, Sulaiman S, Tan HK. From the frontlines of COVID-19 – how prepared are we as obstetricians: a commentary. *BJOG: An International Journal of Obstetrics & Gynaecology*. [Internet]. 2020 March 04 [cited 2020 March 16]; DOI:10.1111/1471-0528.16192.
39. Rhodes A, Evans LE, Alhazzani W, Levy MM, Antonelli M, Ferrer R, et al. Surviving Sepsis Campaign: International Guidelines for Management of Sepsis and Septic Shock: 2016. *Critical Care Medicine* 2017;45(3):486-552.
40. Bowyer L, Robinson HL, Barrett H, Crozier TM, Giles M, Idel I, et al. SOMANZ guidelines for the investigation and management sepsis in pregnancy. *Aust N Z J Obstet Gynaecol* 2017;57(5):540-51.
41. Bikdeli B, Madhavan M, Jimenez D, Chuich T, Dreyfus I, Driggin E, et al. COVID-19 and thrombotic or thromboembolic disease: implications for prevention, antithrombotic therapy, and follow-up. *Journal of American College of Cardiology*. [Internet]. 2020 [cited 2020, April 24]; DOI:<https://doi.org/10.1016/j.jacc.2020.04.031>.
42. Queensland Clinical Guidelines. Venous thromboembolism (VTE) prophylaxis in pregnancy and the puerperium. Guideline No. MN20.9-V6-R25. [Internet]. Queensland Health. 2020. [cited 2020 April 24]. Available from: <https://www.health.qld.gov.au/qcg>
43. American College of Cardiology. Thrombosis and COVID-19: FAQs for current practice. [Internet]. 2020, April 22 [cited 2020 April 24]. Available from: <https://www.acc.org/latest-in-cardiology/articles/2020/04/17/14/42/thrombosis-and-coronavirus-disease-2019-covid-19-faqs-for-current-practice>.
44. The Society of Maternal-Fetal Medicine (SMFM), Dotters-Katz S, Hughes B. Coronavirus (COVID-19) and pregnancy: What maternal-fetal medicine subspecialists need to know. [Internet]. 2020 [cited 2020 March 17]. Available from: [https://s3.amazonaws.com/cdn.smfm.org/media/2262/COVID19\\_PDF.pdf](https://s3.amazonaws.com/cdn.smfm.org/media/2262/COVID19_PDF.pdf).
45. Oster ME, Riehle-Colarusso T, Alverson CJ, Correa A. Associations Between Maternal Fever and Influenza and Congenital Heart Defects. *J. Pediatr*. 2011;158(6):990-5.
46. Shaw GM, Todoroff K, Velie EM, Lammer EJ. Maternal illness, including fever, and medication use as risk factors for neural tube defects. *Teratology* 1998;57(1):1-7.
47. Sass L, Urhoj SK, Kjaergaard J, Dreier JW, Strandberg-Larsen K, Nybo Andersen AM. Fever in pregnancy and the risk of congenital malformations: a cohort study. *BMC Pregnancy and Childbirth* 2017;17(1).
48. Dreier JW, Andersen A-MN, Berg-Beckhoff G. Systematic review and meta-analyses: fever in pregnancy and health impacts in the offspring. *Pediatrics* 2014;133(3):e674-e88.
49. McIntosh JJ. Corticosteroid guidance for pregnancy during COVID-19 pandemic. *Am J Perinatol* 2020.
50. Zha L, Li S, Pan L, Tefsen B, Li Y, French N, et al. Corticosteroid treatment of patients with coronavirus disease 2019 (COVID-19). *Med J Aust* 2020.
51. Solaimanzadeh I. Acetazolamide, Nifedipine and Phosphodiesterase Inhibitors: Rationale for Their Utilization as Adjunctive Countermeasures in the Treatment of Coronavirus Disease 2019 (COVID-19). *Cureus* 2020;12(3):e7343-e.
52. Federal Drug Administration. FDA advises patients on use of non-steroidal anti-inflammatory drugs (NSAIDs) for COVID-19. [Internet]. 2020 March 19 [cited 2020 April 24]. Available from:

<https://www.fda.gov/drugs/drug-safety-and-availability/fda-advises-patients-use-non-steroidal-anti-inflammatory-drugs-nsaids-covid-19>.

53. The Royal Australian and New Zealand College of Obstetricians and Gynaecologists (RANZCOG). COVID-19 Statement. [Internet]. 2020 March 23 [cited 2020 March 24]. Available from: <https://ranzcog.edu.au>.
54. Queensland Clinical Guidelines. Normal birth. Guideline No. MN17.25-V3-R22. [Internet]. Queensland Health. 2015. [cited 2020 April 10]. Available from: <https://www.health.qld.gov.au/qcg>
55. The Royal Australian and New Zealand College of Obstetricians and Gynaecologists (RANZCOG). FAQ: Is it safe to perform fetal blood sampling and/or use fetal scalp electrodes? [Internet]. 2020 April 04 [cited 2020 April 10]. Available from: <https://ranzcog.edu.au>.
56. Society for Obstetric Anesthesia and Perinatology (SOAP). Interim considerations for obstetric anesthesia care related to COVID-19. [Internet]. 2020 April 05 [cited 2020 April 09]. Available from: <https://soap.org>.
57. Email communication from Biomedical Technology Services Queensland Health. Nitrous oxide circuit and filter use for COVID-19 2020 April 09.
58. Centers for Disease Control and Prevention (CDC). Interim considerations for infection prevention and control of coronavirus disease 2019 (COVID-19) in inpatient obstetric healthcare. [Internet]. 2020 [cited 2020 March 06]. Available from: <https://www.cdc.gov/coronavirus/2019-nCoV/hcp/infection-control.html>
59. Neonatal COVID-19 Advisory Group for NSW and ACT. Management of newborn infants born to women with suspected or confirmed COVID-19 (version 13). [Internet]. 2020 March 29 [cited 2020 April 6].
60. European Milk Bank Association. COVID-19: EMBA Position Statement. [Internet]. 2020 [cited 2020 March 18]. Available from: <https://europeanmilkbanking.com/covid-19-emba-position-statement>.
61. Wang S, Guo L, Chen L, Liu W, Cao Y, Zhang J, et al. A case report of neonatal COVID-19 infection in China. [Internet]. 2020 [cited 2020 March 16]; DOI:10.1093/cid/ciaa225/5803274.
62. Zhu H, Wang L, Fang C, Peng S, Zhang L, Chang G, et al. Clinical analysis of 10 neonates born to mothers with 2019-nCoV pneumonia. *Translational Pediatrics* 2020;9(1).
63. Wang S, Guo L, Chen L, Liu W, Cao Y, Zhang J, et al. A case report of neonatal COVID-19 infection in China. *Clin Infect Dis* 2020.
64. Royal College of Paediatrics and Child Health (RCPCH). COVID-19--guidance for neonatal settings. [Internet] 2020 April 08 [cited 2020 April 09]. Available from: <https://www.rcpch.ac.uk>.
65. Tregoning JS, Schwarze J. Respiratory viral infections in infants: causes, clinical symptoms, virology, and immunology. *Clinical microbiology reviews* 2010;23(1):74-98.
66. Royal College of Paediatrics and Child Health (RCPCH). COVID-19--guidance for paediatric services. [Internet] 2020 [cited 2020 March 18]. Available from: <https://www.rcpch.ac.uk>.
67. Queensland Clinical Guidelines. Neonatal resuscitation. Guideline No. MN16.5-V5-R21. [Internet]. Queensland Health. 2016. [cited 2020 April 06]. Available from: <https://www.health.qld.gov.au/qcg>
68. De Luca D. Managing neonates with respiratory failure due to SARS-CoV-2. *Lancet Child Adolesc Health*. 2020 March 6;S2352-4642(20).
69. Queensland Neonatal Clinicians (including Dr Pieter Koorts and Dr Guan Koh). Multi-national neonatal teleconference between Italy, China and Australia. March 19 2020.
70. Lu X, Zhang L, Du H, Zhang J, Li YY, Qu J, et al. SARS-CoV-2 Infection in children. [Internet]. 2020 [cited 2020 March 20]. Available from: <https://www.nejm.org/doi/full/10.1056/NEJMc2005073>  
DOI:10.1056/NEJMc2005073.

## Appendix A: Modified schedules for low-risk women during COVID-19

### Overarching principles for schedule modification during peripartum period

- Reduce number/duration of face to face contacts (F2F) to reduce risk of virus transmission
  - Limit F2F to less than 15 minutes
  - Conduct F2F with minimum number of people (preferably woman only)
  - Minimise time in appointment waiting areas
  - Consider hybrid models (F2F and telehealth) (e.g. for booking in visit)
- Schedule F2F around care that requires physical interaction/care (e.g. vaccination)
- Individualise schedule to meet the needs of the woman, health service/provider and the model of care

### Antenatal schedule

If risk of community transmission is low or reduces, consider replacing telehealth with F2F in the third trimester. (e.g. two additional F2F at 30 and 36 weeks or four additional F2F at 30, 36, 38 and 40 weeks)

#### During every F2F contact

- Perform usual clinical assessments (e.g. BP, fundal height, fetal heart, weight, urinalysis)
- Ask about fetal movements, mental wellbeing, domestic violence

Gestation	Contact type	COVID-19 recommendations for low risk woman
< 12 weeks (or first visit)	F2F	<ul style="list-style-type: none"> <li>• Recommend influenza vaccination</li> <li>• If high risk for GDM, HbA1c instead of OGTT</li> <li>• Consider dating scan (6–8 weeks) for dates, viability, location</li> <li>• Recommend nuchal scan (11–13 weeks) +/- NIPT (<math>\geq 10</math> weeks)</li> <li>• Give referral for routine antenatal blood tests               <ul style="list-style-type: none"> <li>○ Add ferritin with Hb assessment (assume blood stock low)</li> </ul> </li> </ul>
12–18 weeks	Telehealth	<ul style="list-style-type: none"> <li>• Plan for hospital booking-in via telehealth/hybrid model</li> <li>• Discuss access to online/virtual antenatal classes</li> <li>• Follow up results of tests via telehealth contact</li> <li>• Recommend morphology scan (18–20 weeks)</li> </ul>
20–22 weeks	F2F	<ul style="list-style-type: none"> <li>• Recommend pertussis vaccination</li> <li>• Give referral for 26–28 week blood tests               <ul style="list-style-type: none"> <li>○ Refer to updated GDM screening recommendations</li> <li>○ Add ferritin with Hb assessment (assume blood stock low)</li> </ul> </li> </ul>
24–26 weeks	Telehealth	<ul style="list-style-type: none"> <li>• Routine antenatal care</li> </ul>
28 weeks	F2F	<ul style="list-style-type: none"> <li>• If indicated, RhD immunoglobulin (anti-D)</li> <li>• Give referral for 36 week bloods               <ul style="list-style-type: none"> <li>○ Add ferritin with Hb assessment (assume blood stock low)</li> </ul> </li> </ul>
31 weeks	Telehealth	<ul style="list-style-type: none"> <li>• Routine antenatal care</li> </ul>
34–37 weeks	One F2F	<ul style="list-style-type: none"> <li>• If indicated, RhD immunoglobulin (anti-D)</li> <li>• Consider USS for growth and position</li> </ul>
	Remainder Telehealth	<ul style="list-style-type: none"> <li>• Routine antenatal care</li> </ul>
38 weeks	Telehealth	<ul style="list-style-type: none"> <li>• Routine antenatal care</li> </ul>
41 weeks	F2F (if required)	<ul style="list-style-type: none"> <li>• Usual considerations for fetal well-being and birth planning</li> </ul>

Postnatal schedule		
Gestation	Contact type	COVID-19 recommendations for low risk woman
0–6 weeks postpartum	F2F	<ul style="list-style-type: none"> <li>Delay GDM follow-up               <ul style="list-style-type: none"> <li>Refer to updated GDM postnatal follow-up recommendations</li> </ul> </li> <li>Perinatal mental health check</li> <li>Ask about domestic violence</li> <li>Routine postnatal care</li> </ul>
	or Telehealth	
6 weeks	F2F	<ul style="list-style-type: none"> <li>Newborn assessment (prioritise growth, eyes, hips, heart)</li> <li>Vaccinations for newborn</li> <li>Check completion of routine newborn follow-ups (e.g. NNST, hearing screen)</li> </ul>

Antenatal and postnatal schedules adapted with permission: from an original by Dr Wendy Burton April 2020

Ultrasound schedule		
Scan	Asymptomatic woman	Symptomatic woman
11+0–13+6 weeks*	<ul style="list-style-type: none"> <li>Combined test</li> <li>Offer non-invasive prenatal testing (NIPT)</li> </ul>	<ul style="list-style-type: none"> <li>Reschedule combined test in 2 weeks if still within gestational-age window</li> <li>Offer NIPT/serum screening and detailed scan 3–4 weeks after quarantine</li> </ul>
18+0–23+0 weeks*	<ul style="list-style-type: none"> <li>Anatomical scan</li> </ul>	<ul style="list-style-type: none"> <li>Reschedule after quarantine in 2–3 weeks</li> </ul>
Fetal growth scan in third trimester	<ul style="list-style-type: none"> <li>Reduce numbers of scans as clinically appropriate               <ul style="list-style-type: none"> <li>Perform only for standard clinical indications</li> </ul> </li> <li>If no clinical review in late pregnancy (no fundal height measurement; fetal heart rate auscultation), consider brief late gestation scan to confirm presentation and fetal wellbeing (biometrics and amniotic fluid volume measurement)</li> </ul>	

\*Source: ISUOG Consensus Statement on organization of routine and specialist obstetric ultrasound services in the context of COVID-19. (2020)

## Appendix B: Recommended nitrous oxide circuits

Where a scavenger system is available, use Equinox® Advantage Analgesia Circuit–MC/4003  
 Where a scavenger system is not available, use Equinox® Advantage Analgesia Circuit–MC/4001

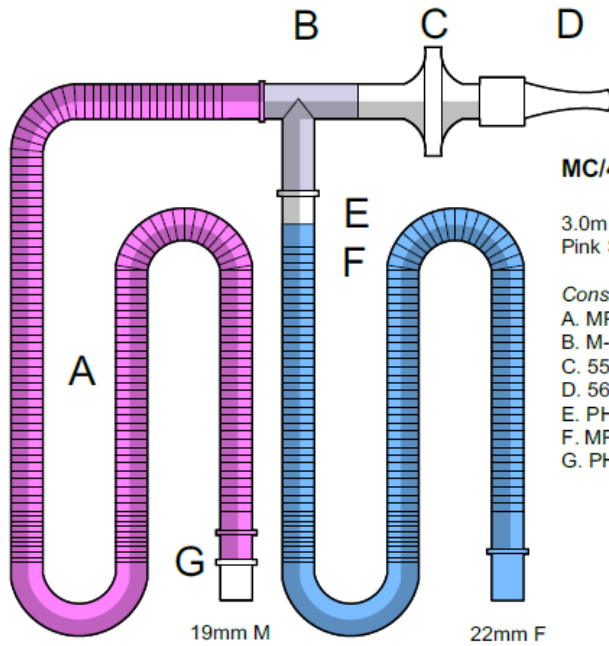

### MC/4003 Equinox® Advantage with Scavenger Limb

3.0m Disposable Patient Circuit with Filter, Mouthpiece and 3.0m Pink Scavenger Tubing with 19mm M Connector

Consisting of:

- A. MP-EX22P120 22mm ID Pink Expandable Tubing PP
- B. M-HP Handpiece 22mm M/M/M with one-way valve (SY)(S)
- C. 55000104-500 In-line Filter 22mm M/F (PP)
- D. 56001 Mouthpiece 22mm F (HDPE)
- E. PH70018 One-way valve 22mm M/F (PP) (S)
- F. MP-EX22B120 22mm ID Blue Expanded Tubing (PP)
- G. PH3200(D) Adaptor 22mm M to 19 mm M(PP)

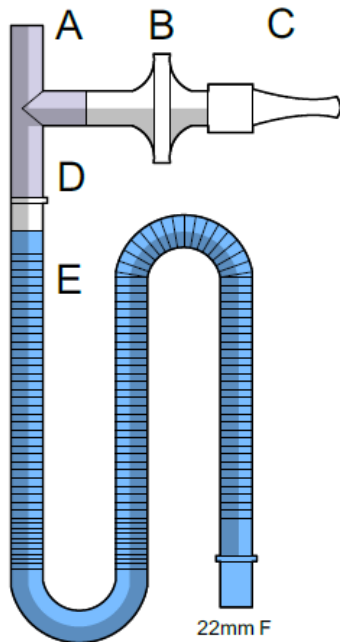

### MC/4001 Equinox® Advantage Single Limb Circuit

3.0m Disposable Patient Circuit with Filter and Mouthpiece

Consisting of:

- A. MC-HP Handpiece 22mm M/M/M with one-way valve (SY) (S)
- B. 55000104-500 In-line Filter 22mm M/F (PP)
- C. 56001 Mouthpiece 22mm F (HDPE)
- D. PH70018 One-way valve 22mm M/F (PP) (S)
- E. MP-EX22B120 22mm ID Blue Expanded Tubing (PP)

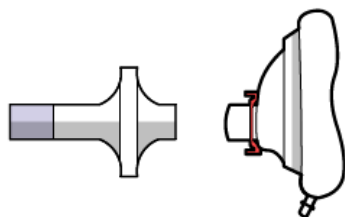

Replace mouthpiece with mask

Recommended by Queensland Health, Biomedical Technology Services for use by suspected or confirmed COVID-19 women

## Appendix C: General principles during initial stabilisation

Aspect	Recommendation
<b>Filter use</b>	<ul style="list-style-type: none"> <li>For all modes of mechanical ventilation use a viral/bacterial neonatal or paediatric filter               <ul style="list-style-type: none"> <li>The viral/bacterial filter may or may not contain a heat and moisture exchanger (HME)</li> </ul> </li> <li>Required for:               <ul style="list-style-type: none"> <li>Self-inflating bags and flow inflating bags/circuits</li> <li>T piece</li> <li>Ventilation circuits</li> </ul> </li> </ul>
<b>Viral/bacterial filter function</b>	<ul style="list-style-type: none"> <li>On inspiration the filter membrane prevents microorganisms reaching the baby and causing cross infection</li> <li>On expiration the filter membrane prevents contamination of the external environment and equipment</li> </ul>
<b>HME filter type</b>	<ul style="list-style-type: none"> <li>There are a range of filters suitable for use—consider:               <ul style="list-style-type: none"> <li>Impact on tidal volume (number of mL added)</li> <li>Connection fit to existing equipment</li> <li>Need for humidification/suitability for humidification</li> <li>Availability of stock</li> </ul> </li> </ul> <p><u>Examples:</u> (others may be suitable)</p> <ul style="list-style-type: none"> <li>Viral/bacterial filter with HME—humidifier is not required               <ul style="list-style-type: none"> <li>Medtronic DAR™ PAEDIATRIC NEONATAL Electrostatic Filter HME SMALL (catalogue number 355/5427)</li> </ul> </li> </ul>
<b>Filter placement</b>	<ul style="list-style-type: none"> <li>Refer to Figure1 for circuit assembly</li> </ul>
<b>Disconnection from circuit</b>	<ul style="list-style-type: none"> <li>Minimise disconnections (as far as possible) because this may increase aerosol dispersion</li> <li>Refer to Figure 1 and disconnect at the recommended point to minimise transmission</li> </ul>
<b>Sourcing filters</b>	<ul style="list-style-type: none"> <li>Order filters through usual procurement processes</li> <li>Consider ordering one box (25) and sharing within Hospital and Health Service (to conserve supply)</li> <li>Stocks may be out or low—check at the time of ordering</li> </ul>
<b>Suctioning</b>	<ul style="list-style-type: none"> <li>If available and is current practice, in-line suctioning is recommended</li> </ul>
<b>Humidification</b>	<ul style="list-style-type: none"> <li>Refer to individual product information as humidification not recommended with some filters</li> </ul>
<b>Nebulisers</b>	<ul style="list-style-type: none"> <li>Conflicting information—avoid until further information               <ul style="list-style-type: none"> <li>Australian and New Zealand Intensive Care Society (1) recommend avoidance</li> <li>Royal College of Paediatrics and Child Health (2) state: <i>During administration of nebulised medication, the aerosol derives from a non-patient source (the fluid in the nebuliser chamber) and does not carry patient-derived viral particles</i></li> </ul> </li> </ul>

(1). The Australian and New Zealand Intensive Care Society (ANZICS). The Australian and New Zealand Intensive Care Society (ANZICS) COVID-19 Guidelines (V1). [Internet]. 2020 March 16 [cited 2020 April 06]. Available from: <https://www.anzics.com.au>.

(2). Royal College of Paediatrics and Child Health. COVID-19-guidance for neonatal settings. [Internet] 2020 April 08 [cited 2020 April 09]. Available from: <https://www.rcpch.ac.uk>.

## COVID-19 BAG VALVE ASSEMBLY

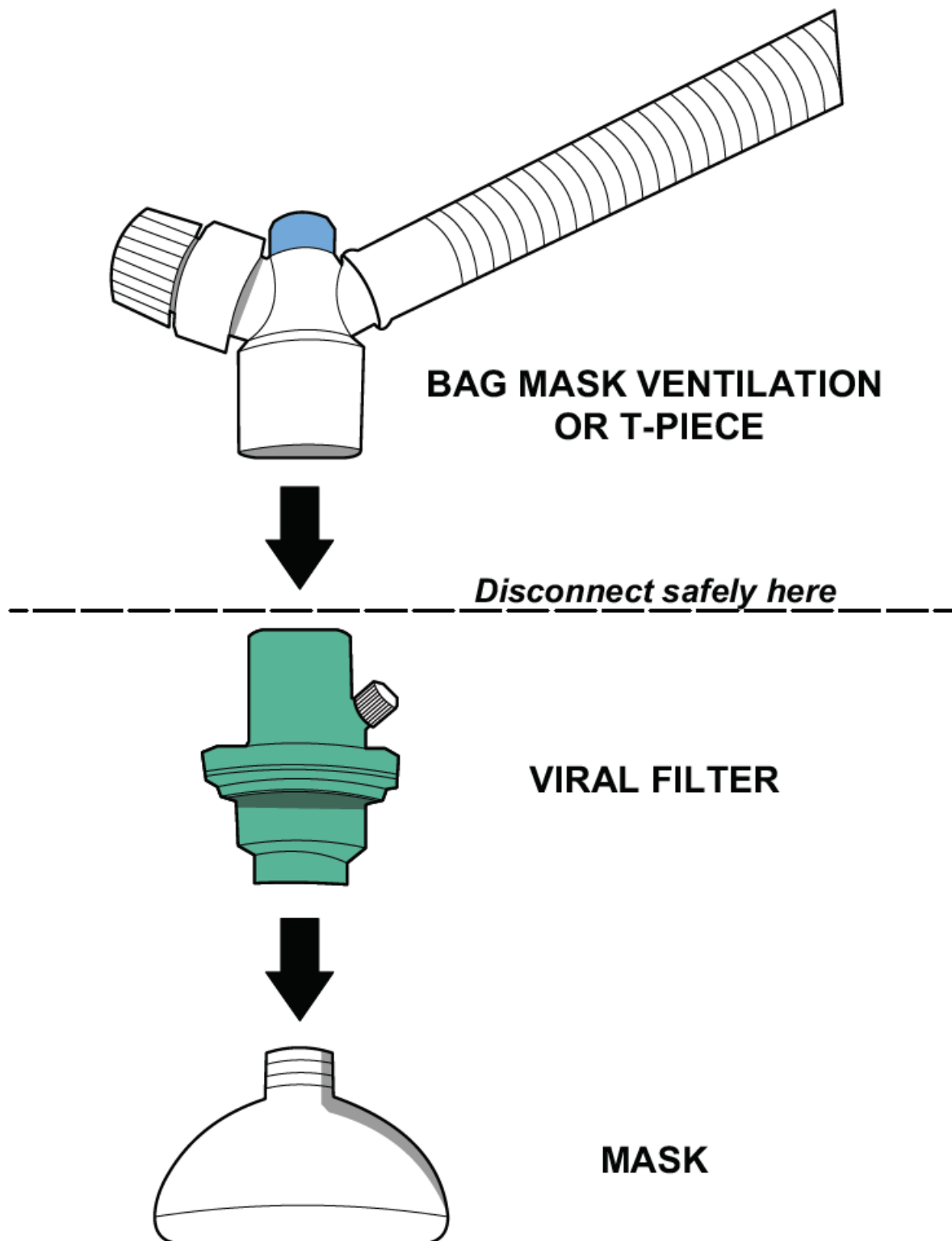

Figure 1: Set up for initial neonatal resuscitation and stabilisation during COVID-19 pandemic

Source: Adapted with permission from Queensland Children's Hospital: *Queensland paediatric consensus statement: paediatric intubation guideline during the COVID-19 outbreak* available at [www.childrens.health.qld.gov.au](http://www.childrens.health.qld.gov.au)



## **Acknowledgements**

Queensland Clinical Guidelines gratefully acknowledge the contribution of Queensland clinicians and other stakeholders who participated throughout the guideline development process particularly:

### **Working Party Co-Clinical Leads**

Associate Professor Rebecca Kimble, Pre-eminent Specialist, Obstetrician and Gynaecologist, Royal Brisbane and Women's Hospital

Dr Pieter Koorts, Director of Neonatology, Royal Brisbane and Women's Hospital

### **QCG Program Officer**

Jacinta Lee, Manager Queensland Clinical Guidelines

**Consultation** A working party was not formally convened. The following invited stakeholders provided feedback and input into this version and/or previous versions.

Ms Rukhsana Aziz, Clinical Midwifery Consultant, Ipswich Hospital

Dr Pita Birch, Director of Neonatology, Mater Health, Brisbane

Ms Ann Bousfield, Clinical Midwifery Consultant, South West Hospital and Health Service

Dr Paul Bretz, Director of Obstetrics and Gynaecology, Mater Health, Brisbane

Dr Wendy Burton, General Practitioner, Morningside General Practice, Brisbane

Professor Leonie Callaway, Director of Research, Royal Brisbane and Women's Hospital

Dr Jeremy Chin, Obstetrician, Northern Territory Health Services

Dr Lindsay Cochrane, Obstetrician and Gynaecologist, Caboolture Hospital, Brisbane

Dr Candice Colbran, Public Health Physician, Aboriginal and Torres Strait Islander Health Division

Ms Li-an Collie, Nurse Educator, Neonatal Retrieval Emergency Service Southern Queensland (NeoRESQ)

Ms Eileen Cooke, Consumer Representative, Preterm Infant Parents' Association

Ms Collen Clur, Chief Strategy Officer, West Morton Hospital and Health Service

Ms Vanessa Curnow, Executive Director, Aboriginal and Torres Strait Islander Health, The Children's Hospital and Health Service

Mr Ashley Currie, Aboriginal and Torres Strait Islander District Co-ordinator, Metro South Hospital and Health Service

Ms Leah Hardiman, Consumer Representative

Dr Graeme Jackson, Director of Obstetrics and Gynaecology, Redcliffe Hospital, Brisbane

Ms Belinda Jennings, Senior Midwifery Advisor, Northern Territory Department of Health

Ms Catherine Marron, Acting Nursing Director, Central Queensland Hospital and Health Service

Ms Linda Medlin, Principal Advisor, Aboriginal and Torres Strait Island Community Health, Central Queensland Hospital and Health Service

Professor Michael Nicholl, Senior Clinical Advisor, Obstetrics, New South Wales Health

Dr Scott Petersen, Maternal Fetal Medicine Specialist, Mater Hospital, Brisbane

Ms Verity Powell, Registered Midwife, Northern Territory Department of Health

Ms Kate Reynolds, Coordinator of Midwifery, Western Australia Country Health

Dr Vijay Roach, President, Royal Australian and New Zealand College of Obstetricians and Gynaecologists (RANZCOG)

Ms Kelly Smith, Service Development Officer, Aboriginal and Torres Strait Islander, Chermside Community Health Centre, Brisbane

Ms Patricia Smith, Nursing and Midwifery Director, Royal Brisbane and Women's Hospital

Ms Rhonda Taylor, Clinical Midwife Consultant, The Townsville Hospital

Dr Jocelyn Toohill, Director of Midwifery, Officer of the Chief Nursing and Midwifery Office Queensland

Professor Ewan Wallace, Chief Executive Officer, Safer Care Victoria

Dr Jennifer Yan, Infectious Diseases Paediatrician, Northern Territory Health Services

### **Queensland Clinical Guidelines Team**

Associate Professor Rebecca Kimble, Director

Ms Jacinta Lee, Manager

Ms Cara Cox, Clinical Nurse Consultant

Ms Stephanie Sutherns, Clinical Nurse Consultant

Ms Emily Holmes, Clinical Nurse Consultant

### **Funding**

This clinical guideline was funded by Healthcare Improvement Unit, Queensland Health